



**SYNERGIX**<sup>®</sup>  
SECURITY SCREWS

# TAMPER RESISTANCE FASTENERS

Speciality Manufacturing & Distribution  
Singapore Company  
ISO 9001 : 2008 | ISO 14001 : 2004

# CONTENTS

	SERIES	DESCRIPTION	UNIT	MATERIAL	FINISH	LOCKING ELEMENT	PAGE		
HP	HP01	HEX PIN BUTTON HEAD SCREW	METRIC	STAINLESS STEEL A2	PASSIVATED   BLACK	✓	4		
	HP02	HEX PIN FLAT HEAD SCREW				✓	6		
	HP03	HEX PIN BUTTON HEAD SHEET METAL SCREW TYPE AB				-/-	8		
	HP04	HEX PIN FLAT HEAD SHEET METAL SCREW TYPE AB				-/-	9		
TP	TP01	TORX PIN BUTTON HEAD SCREW				✓	10		
	TP02	TORX PIN FLAT HEAD SCREW				✓	12		
	TP03	TORX PIN BUTTON HEAD SHEET METAL SCREW TYPE AB				-/-	14		
	TP04	TORX PIN FLAT HEAD SHEET METAL SCREW TYPE AB				-/-	15		
DS	DS01	DRILLED SPANNER PAN HEAD MACHINE SCREW				✓	16		
	DS02	DRILLED SPANNER FLAT MACHINE HEAD SCREW				✓	18		
	DS03	DRILLED SPANNER PAN HEAD SHEET METAL SCREW TYPE AB				-/-	20		
	DS04	DRILLED SPANNER FLAT HEAD SHEET METAL SCREW TYPE AB				-/-	21		
	DS05	DRILLED SPANNER RAISED FLAT HEAD SHEET METAL SCREW				-/-	22		
	DS06	DRILLED SPANNER NUT REVERSIBLE				-/-	23		
OW	OW01	ONE WAY ROUND HEAD MACHINE SCREW				✓	24		
	OW03	ONE WAY ROUND HEAD SHEET METAL SCREW				-/-	26		
	OW04	ONE WAY RAISED FLAT HEAD SHEET METAL SCREW				-/-	27		
SM	SM01	SYSTEM MICRO EXTERNAL TYPE A MACHINE SCREW				✓	28		
	SM02	SYSTEM MICRO EXTERNAL TYPE B MACHINE SCREW				✓	29		
TR	TR01	TRIO PIN BUTTON HEAD SCREW				✓	30		
TW	TW01	TRI WING BUTTON HEAD SCREW				✓	32		
	TW02	TRI WING FLAT HEAD SCREW				✓	34		
PP	PP01	PHILIP PIN PAN HEAD MACHINE SCREW				✓	36		
TN	TN01	BREAKAWAY TAMPER NUT   NON-REMOVABLE				-/-	37		
TOOLS	TOOLS SELECTION PAGE					-/-	-/-	-/-	38

# CONTENTS

	SERIES	DESCRIPTION	UNIT	MATERIAL	FINISH	LOCKING ELEMENT	PAGE					
HP	HP01	HEX PIN BUTTON HEAD SCREW	INCH	STAINLESS STEEL 18-8	PASSIVATED   BLACK	✓	44					
	HP02	HEX PIN FLAT HEAD SCREW				✓	46					
	HP03	HEX PIN BUTTON HEAD SHEET METAL SCREW TYPE AB				-/-	48					
	HP04	HEX PIN FLAT HEAD SHEET METAL SCREW TYPE AB				-/-	49					
TP	TP01	TORX PIN BUTTON HEAD SCREW				✓	50					
	TP02	TORX PIN FLAT HEAD SCREW				✓	52					
	TP03	TORX PIN BUTTON HEAD SHEET METAL SCREW TYPE AB				-/-	54					
	TP04	TORX PIN FLAT HEAD SHEET METAL SCREW TYPE AB				-/-	55					
DS	DS01	DRILLED SPANNER PAN HEAD MACHINE SCREW				✓	56					
	DS02	DRILLED SPANNER FLAT MACHINE HEAD SCREW				✓	58					
	DS03	DRILLED SPANNER PAN HEAD SHEET METAL SCREW TYPE AB				-/-	60					
	DS04	DRILLED SPANNER FLAT HEAD SHEET METAL SCREW TYPE AB				-/-	61					
TOOLS	TOOLS SELECTION PAGE					-/-	-/-	-/-	62			
ASST.	ASST HP01	ASSORTMENT - HEX PIN BUTTON SERIES				METRIC	STAINLESS STEEL A2	-/-	-/-	66		
	ASST HP02	ASSORTMENT - HEX PIN FLAT SERIES						-/-	-/-	66		
ASST TB	ASSORTMENT TOOLS - HEX PIN SERIES	-/-						-/-	66			
ASST TP01	ASSORTMENT - TORX PIN BUTTON SERIES	-/-						-/-	67			
ASST TP02	ASSORTMENT - TORX PIN FLAT SERIES	-/-						-/-	67			
ASST TB	ASSORTMENT TOOLS - TORX PIN SERIES	-/-						-/-	67			
ASST.	ASST HP01	ASSORTMENT - HEX PIN BUTTON SERIES						INCH	STAINLESS STEEL 18-8	-/-	-/-	68
	ASST HP02	ASSORTMENT - HEX PIN FLAT SERIES								-/-	-/-	68
ASST TB	ASSORTMENT TOOLS - HEX PIN SERIES	-/-								-/-	68	
ASST TP01	ASSORTMENT - TORX PIN BUTTON SERIES	-/-								-/-	69	
ASST TP02	ASSORTMENT - TORX PIN FLAT SERIES	-/-								-/-	69	
ASST TB	ASSORTMENT TOOLS - TORX PIN SERIES	-/-								-/-	69	





**SYNERGIX**<sup>®</sup>  
SECURITY SCREWS



**SYNERGIX**<sup>®</sup>  
SECURITY SCREWS

**TAMPER  
RESISTANCE  
FASTENERS**

**METRIC SERIES**





**THEFT RESISTANT SCREW (TRS)**

**HEXAGON BUTTON WITH PIN**

MEASUREMENT: METRIC  
 MATERIAL: STAINLESS STEEL A2  
 FINISH: PASSIVATED | BLACK | THREAD LOCK

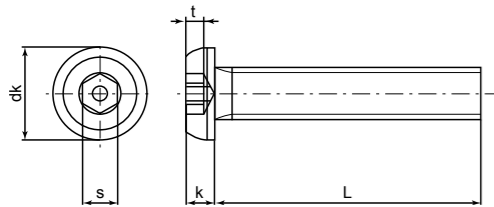

	M3	M4	M5	M6	M8	M10	M12
dk	5.6	7.6	9.7	10.7	14.2	18.5	21.5
k	1.7	2.2	2.8	3.3	4.5	5.5	6.6
s	2	2.5	3	4	5	6	8
L	6-25mm	6-40mm	10-60mm	10-60mm	10-60mm	16-90mm	20-60mm

PART NUMBER			D	L	BOX QTY
SST (A2)	SS + BLACKEN	SST + THREAD LOCK			
SFHP01-0306SS	SFHP01-0306SS-BL	SFHP01-0306SS-NY	M3	6mm	100
SFHP01-0308SS	SFHP01-0308SS-BL	SFHP01-0308SS-NY		8mm	
SFHP01-0310SS	SFHP01-0310SS-BL	SFHP01-0310SS-NY		10mm	
SFHP01-0312SS	SFHP01-0312SS-BL	SFHP01-0312SS-NY		12mm	
SFHP01-0316SS	SFHP01-0316SS-BL	SFHP01-0316SS-NY		16mm	
SFHP01-0320SS	SFHP01-0320SS-BL	SFHP01-0320SS-NY		20mm	
SFHP01-0325SS	SFHP01-0325SS-BL	SFHP01-0325SS-NY		25mm	

SFHP01-0406SS	SFHP01-0406SS-BL	SFHP01-0406SS-NY	M4	6mm	100
SFHP01-0408SS	SFHP01-0408SS-BL	SFHP01-0408SS-NY		8mm	
SFHP01-0410SS	SFHP01-0410SS-BL	SFHP01-0410SS-NY		10mm	
SFHP01-0412SS	SFHP01-0412SS-BL	SFHP01-0412SS-NY		12mm	
SFHP01-0416SS	SFHP01-0416SS-BL	SFHP01-0416SS-NY		16mm	
SFHP01-0420SS	SFHP01-0420SS-BL	SFHP01-0420SS-NY		20mm	
SFHP01-0425SS	SFHP01-0425SS-BL	SFHP01-0425SS-NY		25mm	
SFHP01-0430SS	SFHP01-0430SS-BL	SFHP01-0430SS-NY	30mm		
SFHP01-0440SS	SFHP01-0440SS-BL	SFHP01-0440SS-NY	40mm		

SFHP01-0510SS	SFHP01-0510SS-BL	SFHP01-0510SS-NY	M5	10mm	100
SFHP01-0512SS	SFHP01-0512SS-BL	SFHP01-0512SS-NY		12mm	
SFHP01-0516SS	SFHP01-0516SS-BL	SFHP01-0516SS-NY		16mm	
SFHP01-0520SS	SFHP01-0520SS-BL	SFHP01-0520SS-NY		20mm	
SFHP01-0525SS	SFHP01-0525SS-BL	SFHP01-0525SS-NY		25mm	
SFHP01-0530SS	SFHP01-0530SS-BL	SFHP01-0530SS-NY		30mm	
SFHP01-0540SS	SFHP01-0540SS-BL	SFHP01-0540SS-NY		40mm	
SFHP01-0550SS	SFHP01-0550SS-BL	SFHP01-0550SS-NY	50mm		
SFHP01-0560SS	SFHP01-0560SS-BL	SFHP01-0560SS-NY	60mm	50	

PART NUMBER			D	L	BOX QTY
SST (A2)	SS + BLACKEN	SST + THREAD LOCK			
SFHP01-0610SS	SFHP01-0610SS-BL	SFHP01-0610SS-NY	M6	10mm	100
SFHP01-0612SS	SFHP01-0612SS-BL	SFHP01-0612SS-NY		12mm	
SFHP01-0616SS	SFHP01-0616SS-BL	SFHP01-0616SS-NY		16mm	
SFHP01-0620SS	SFHP01-0620SS-BL	SFHP01-0620SS-NY		20mm	
SFHP01-0625SS	SFHP01-0625SS-BL	SFHP01-0625SS-NY		25mm	
SFHP01-0630SS	SFHP01-0630SS-BL	SFHP01-0630SS-NY		30mm	
SFHP01-0640SS	SFHP01-0640SS-BL	SFHP01-0640SS-NY		40mm	
SFHP01-0650SS	SFHP01-0650SS-BL	SFHP01-0650SS-NY	50mm	50	
SFHP01-0660SS	SFHP01-0660SS-BL	SFHP01-0660SS-NY	60mm		

SFHP01-0810SS	SFHP01-0810SS-BL	SFHP01-0810SS-NY	M8	10mm	100
SFHP01-0812SS	SFHP01-0812SS-BL	SFHP01-0812SS-NY		12mm	
SFHP01-0816SS	SFHP01-0816SS-BL	SFHP01-0816SS-NY		16mm	
SFHP01-0820SS	SFHP01-0820SS-BL	SFHP01-0820SS-NY		20mm	
SFHP01-0825SS	SFHP01-0825SS-BL	SFHP01-0825SS-NY		25mm	
SFHP01-0830SS	SFHP01-0830SS-BL	SFHP01-0830SS-NY		30mm	
SFHP01-0840SS	SFHP01-0840SS-BL	SFHP01-0840SS-NY		40mm	
SFHP01-0850SS	SFHP01-0850SS-BL	SFHP01-0850SS-NY	50mm	50	
SFHP01-0860SS	SFHP01-0860SS-BL	SFHP01-0860SS-NY	60mm		

SFHP01-1016SS	SFHP01-1016SS-BL	SFHP01-1016SS-NY	M10	16mm	50
SFHP01-1020SS	SFHP01-1020SS-BL	SFHP01-1020SS-NY		20mm	
SFHP01-1025SS	SFHP01-1025SS-BL	SFHP01-1025SS-NY		25mm	
SFHP01-1030SS	SFHP01-1030SS-BL	SFHP01-1030SS-NY		30mm	
SFHP01-1040SS	SFHP01-1040SS-BL	SFHP01-1040SS-NY		40mm	
SFHP01-1045SS	SFHP01-1045SS-BL	SFHP01-1045SS-NY		45mm	
SFHP01-1050SS	SFHP01-1050SS-BL	SFHP01-1050SS-NY		50mm	
SFHP01-1055SS	SFHP01-1055SS-BL	SFHP01-1055SS-NY	55mm	25	
SFHP01-1060SS	SFHP01-1060SS-BL	SFHP01-1060SS-NY	60mm		
SFHP01-1070SS	SFHP01-1070SS-BL	SFHP01-1070SS-NY	70mm		
SFHP01-1075SS	SFHP01-1075SS-BL	SFHP01-1075SS-NY	75mm		
SFHP01-1080SS	SFHP01-1080SS-BL	SFHP01-1080SS-NY	80mm		
SFHP01-1090SS	SFHP01-1090SS-BL	SFHP01-1090SS-NY	90mm		

SFHP01-1220SS	SFHP01-1220SS-BL	SFHP01-1220SS-NY	M12	20mm	10	
SFHP01-1225SS	SFHP01-1225SS-BL	SFHP01-1225SS-NY		25mm		
SFHP01-1230SS	SFHP01-1230SS-BL	SFHP01-1230SS-NY		30mm		
SFHP01-1240SS	SFHP01-1240SS-BL	SFHP01-1240SS-NY		40mm		
SFHP01-1250SS	SFHP01-1250SS-BL	SFHP01-1250SS-NY		50mm		5
SFHP01-1260SS	SFHP01-1260SS-BL	SFHP01-1260SS-NY		60mm		

**THREAD LOCKER**

- Reliable, Power Lock
- Multiple Reuse
- Minimizes Galling / Stripping
- Cost Saving

REFER TO PAGE 38 FOR TOOLS

BACK

**THEFT RESISTANT SCREW (TRS)**



**HEXAGON FLAT WITH PIN**

MEASUREMENT: **METRIC**  
 MATERIAL: **STAINLESS STEEL A2**  
 FINISH: **PASSIVATED | BLACK | THREAD LOCK**

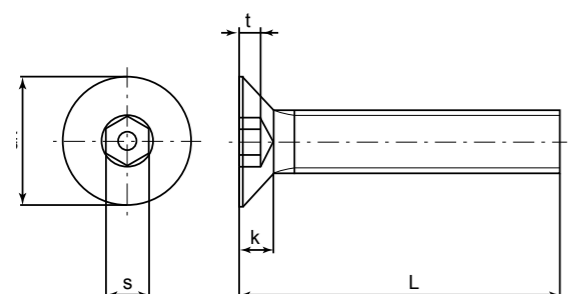

	M3	M4	M5	M6	M8
dk	6	8	10	12	16
k	1.75	2.4	2.95	3.45	4.6
s	2	2.5	3	4	5
L	6-25mm	8-40mm	8-60mm	10-60mm	10-60mm

PART NUMBER			D	L	BOX QTY
SST (A2)	SS + BLACKEN	SST + <b>THREAD LOCK</b>			
SFHP02-0306SS	SFHP02-0306SS-BL	SFHP02-0306SS-NY	M3	6mm	100
SFHP02-0308SS	SFHP02-0308SS-BL	SFHP02-0308SS-NY		8mm	
SFHP02-0310SS	SFHP02-0310SS-BL	SFHP02-0310SS-NY		10mm	
SFHP02-0312SS	SFHP02-0312SS-BL	SFHP02-0312SS-NY		12mm	
SFHP02-0316SS	SFHP02-0316SS-BL	SFHP02-0316SS-NY		16mm	
SFHP02-0320SS	SFHP02-0320SS-BL	SFHP02-0320SS-NY		20mm	
SFHP02-0325SS	SFHP02-0325SS-BL	SFHP02-0325SS-NY		25mm	

SFHP02-0408SS	SFHP02-0408SS-BL	SFHP02-0408SS-NY	M4	8mm	100
SFHP02-0410SS	SFHP02-0410SS-BL	SFHP02-0410SS-NY		10mm	
SFHP02-0412SS	SFHP02-0412SS-BL	SFHP02-0412SS-NY		12mm	
SFHP02-0416SS	SFHP02-0416SS-BL	SFHP02-0416SS-NY		16mm	
SFHP02-0420SS	SFHP02-0420SS-BL	SFHP02-0420SS-NY		20mm	
SFHP02-0425SS	SFHP02-0425SS-BL	SFHP02-0425SS-NY		25mm	
SFHP02-0430SS	SFHP02-0430SS-BL	SFHP02-0430SS-NY		30mm	
SFHP02-0440SS	SFHP02-0440SS-BL	SFHP02-0440SS-NY		40mm	

SFHP02-0508SS	SFHP02-0508SS-BL	SFHP02-0508SS-NY	M5	8mm	100
SFHP02-0510SS	SFHP02-0510SS-BL	SFHP02-0510SS-NY		10mm	
SFHP02-0512SS	SFHP02-0512SS-BL	SFHPV02-0512SS-NY		12mm	
SFHP02-0516SS	SFHP02-0516SS-BL	SFHP02-0516SS-NY		16mm	
SFHP02-0520SS	SFHP02-0520SS-BL	SFHP02-0520SS-NY		20mm	
SFHP02-0525SS	SFHP02-0525SS-BL	SFHP02-0525SS-NY		25mm	
SFHP02-0530SS	SFHP02-0530SS-BL	SFHP02-0530SS-NY		30mm	
SFHP02-0540SS	SFHP02-0540SS-BL	SFHP02-0540SS-NY		40mm	
SFHP02-0550SS	SFHP02-0550SS-BL	SFHP02-0550SS-NY		50mm	
SFHP02-0560SS	SFHP02-0560SS-BL	SFHP02-0560SS-NY		60mm	

PART NUMBER			D	L	BOX QTY
SST (A2)	SS + BLACKEN	SST + <b>THREAD LOCK</b>			
SFHP02-0610SS	SFHP02-0610SS-BL	SFHP02-0610SS-NY	M6	10mm	100
SFHP02-0612SS	SFHP02-0612SS-BL	SFHP02-0612SS-NY		12mm	
SFHP02-0616SS	SFHP02-0616SS-BL	SFHP02-0616SS-NY		16mm	
SFHP02-0620SS	SFHP02-0620SS-BL	SFHP02-0620SS-NY		20mm	
SFHP02-0625SS	SFHP02-0625SS-BL	SFHP02-0625SS-NY		25mm	
SFHP02-0630SS	SFHP02-0630SS-BL	SFHP02-0630SS-NY		30mm	
SFHP02-0640SS	SFHP02-0640SS-BL	SFHP02-0640SS-NY	50	40mm	
SFHP02-0650SS	SFHP02-0650SS-BL	SFHP02-0650SS-NY		50mm	
SFHP02-0660SS	SFHP02-0660SS-BL	SFHP02-0660SS-NY		60mm	

SFHP02-0810SS	SFHP02-0810SS-BL	SFHP02-0810SS-NY	M8	10mm	100
SFHP02-0812SS	SFHP02-0812SS-BL	SFHP02-0812SS-NY		12mm	
SFHP02-0816SS	SFHP02-0816SS-BL	SFHP02-0816SS-NY		16mm	
SFHP02-0820SS	SFHP02-0820SS-BL	SFHP02-0820SS-NY		20mm	
SFHP02-0825SS	SFHP02-0825SS-BL	SFHP02-0825SS-NY		25mm	
SFHP02-0830SS	SFHP02-0830SS-BL	SFHP02-0830SS-NY		30mm	
SFHP02-0840SS	SFHP02-0840SS-BL	SFHP02-0840SS-NY		40mm	
SFHP02-0850SS	SFHP02-0850SS-BL	SFHP02-0850SS-NY		50mm	
SFHP02-0860SS	SFHP02-0860SS-BL	SFHP02-0860SS-NY		60mm	

**THREAD LOCKER**

- Reliable, Power Lock
- Multiple Reuse
- Minimizes Galling / Stripping
- Cost Saving

REFER TO PAGE 38 FOR TOOLS



HP  
 TP  
 DS  
 OW  
 SM  
 TR  
 TW  
 PP  
 TN

HP  
 TP  
 DS  
 OW  
 SM  
 TR  
 TW  
 PP  
 TN

THEFT RESISTANT SCREW (TRS)



HEX PIN BUTTON HEAD SHEET METAL SCREW TYPE AB

MEASUREMENT: METRIC  
MATERIAL: STAINLESS STEEL A2  
FINISH: PASSIVATED | BLACK

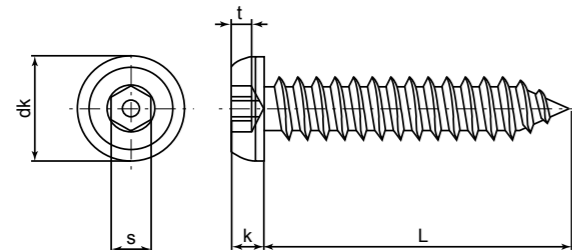

	3.5	4.2	4.8	6.3
dk	5.7	7.6	9.5	10.5
k	1.65	2.2	2.75	3.3
s	SW 2	SW 2.5	SW 3	SW 4

PART NUMBER		D	L	BOX QTY
SST (A2)	SS + BLACKEN			
SFHP03-3510SS	SFHP03-3510SS-BL	3.5	10	100
SFHP03-3513SS	SFHP03-3513SS-BL		13	
SFHP03-3516SS	SFHP03-3516SS-BL		16	
SFHP03-3519SS	SFHP03-3519SS-BL		19	
SFHP03-3525SS	SFHP03-3525SS-BL		25	
SFHP03-3532SS	SFHP03-3532SS-BL		32	
SFHP03-3538SS	SFHP03-3538SS-BL	38		
SFHP03-3550SS	SFHP03-3550SS-BL	50		
SFHP03-4210SS	SFHP03-4210SS-BL	4.2	10	100
SFHP03-4213SS	SFHP03-4213SS-BL		13	
SFHP03-4216SS	SFHP03-4216SS-BL		16	
SFHP03-4219SS	SFHP03-4219SS-BL		19	
SFHP03-4225SS	SFHP03-4225SS-BL		25	
SFHP03-4232SS	SFHP03-4232SS-BL		32	
SFHP03-4238SS	SFHP03-4238SS-BL		38	
SFHP03-4250SS	SFHP03-4250SS-BL		50	

PART NUMBER		D	L	BOX QTY
SST (A2)	SS + BLACKEN			
SFHP03-4813SS	SFHP03-4813SS-BL	4.8	13	100
SFHP03-4816SS	SFHP03-4816SS-BL		16	
SFHP03-4819SS	SFHP03-4819SS-BL		19	
SFHP03-4825SS	SFHP03-4825SS-BL		25	
SFHP03-4832SS	SFHP03-4832SS-BL		32	
SFHP03-4838SS	SFHP03-4838SS-BL		38	
SFHP03-4850SS	SFHP03-4850SS-BL	50		
SFHP03-6313SS	SFHP03-6313SS-BL	6.3	13	100
SFHP03-6316SS	SFHP03-6316SS-BL		16	
SFHP03-6319SS	SFHP03-6319SS-BL		19	
SFHP03-6325SS	SFHP03-6325SS-BL		25	
SFHP03-6332SS	SFHP03-6332SS-BL		32	
SFHP03-6338SS	SFHP03-6338SS-BL		38	
SFHP03-6350SS	SFHP03-6350SS-BL		50	

THEFT RESISTANT SCREW (TRS)



HEX PIN FLAT HEAD SHEET METAL SCREW TYPE AB

MEASUREMENT: METRIC  
MATERIAL: STAINLESS STEEL A2  
FINISH: PASSIVATED | BLACK

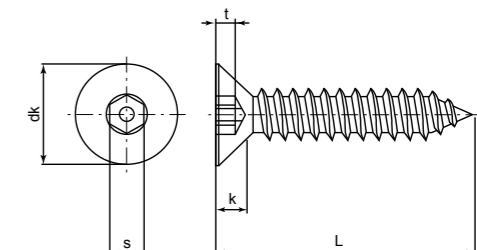

	3.5	4.2	4.8	5.5	6.3
dk	6.8	8.1	9.5	10.8	12.4
k	2.15	2.6	3.15	3.55	4
s	SW 2	SW 2.5	SW 3	SW 4	SW 4

PART NUMBER		D	L	BOX QTY
SST (A2)	SS + BLACKEN			
SFHP04-3510SS	SFHP04-3510SS-BL	3.5	10	100
SFHP04-3513SS	SFHP04-3513SS-BL		13	
SFHP04-3516SS	SFHP04-3516SS-BL		16	
SFHP04-3519SS	SFHP04-3519SS-BL		19	
SFHP04-3525SS	SFHP04-3525SS-BL		25	
SFHP04-3532SS	SFHP04-3532SS-BL		32	
SFHP04-3538SS	SFHP04-3538SS-BL	38		
SFHP04-4213SS	SFHP04-4213SS-BL	4.2	13	100
SFHP04-4216SS	SFHP04-4216SS-BL		16	
SFHP04-4219SS	SFHP04-4219SS-BL		19	
SFHP04-4225SS	SFHP04-4225SS-BL		25	
SFHP04-4232SS	SFHP04-4232SS-BL		32	
SFHP04-4238SS	SFHP04-4238SS-BL		38	
SFHP04-4250SS	SFHP04-4250SS-BL		50	
SFHP04-4813SS	SFHP04-4813SS-BL		4.8	
SFHP04-4816SS	SFHP04-4816SS-BL	16		
SFHP04-4819SS	SFHP04-4819SS-BL	19		
SFHP04-4825SS	SFHP04-4825SS-BL	25		
SFHP04-4832SS	SFHP04-4832SS-BL	32		
SFHP04-4838SS	SFHP04-4838SS-BL	38		
SFHP04-4850SS	SFHP04-4850SS-BL	50		

PART NUMBER		D	L	BOX QTY
SST (A2)	SS + BLACKEN			
SFHP04-5513SS	SFHP04-5513SS-BL	5.5	13	100
SFHP04-5516SS	SFHP04-5516SS-BL		16	
SFHP04-5519SS	SFHP04-5519SS-BL		19	
SFHP04-5525SS	SFHP04-5525SS-BL		25	
SFHP04-5532SS	SFHP04-5532SS-BL		32	
SFHP04-5538SS	SFHP04-5538SS-BL		38	
SFHP04-5550SS	SFHP04-5550SS-BL	50		
SFHP04-6316SS	SFHP04-6316SS-BL	6.3	16	50
SFHP04-6319SS	SFHP04-6319SS-BL		19	
SFHP04-6325SS	SFHP04-6325SS-BL		25	
SFHP04-6332SS	SFHP04-6332SS-BL		32	
SFHP04-6338SS	SFHP04-6338SS-BL		38	
SFHP04-6350SS	SFHP04-6350SS-BL		50	

- HP
- TP
- DS
- OW
- SM
- TR
- TW
- PP
- TN

- HP
- TP
- DS
- OW
- SM
- TR
- TW
- PP
- TN

REFER TO PAGE 38 FOR TOOLS



**THEFT RESISTANT SCREW (TRS)**

**TORX PIN BUTTON HEAD SCREW**

MEASUREMENT: METRIC  
 MATERIAL: STAINLESS STEEL A2  
 FINISH: PASSIVATED | BLACK | THREAD LOCK



	M3	M4	M5	M6	M8	M10
dk	5.7	7.6	9.5	10.5	14	17.5
k	1.65	2.2	2.75	3.3	4.4	5.5
s	TX10	TX20	TX25	TX30	TX40	TX45
L	6-50mm	6-100mm	8-100mm	8-100mm	10-100mm	16-70mm

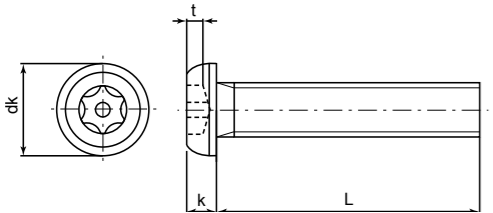

PART NUMBER			D	L	BOX QTY		
SST (A2)	SS + BLACKEN	SST + THREAD LOCK					
SFTP01-0306SS	SFTP01-0306SS-BL	SFTP01-0306SS-NY	M3	6mm	100		
SFTP01-0308SS	SFTP01-0308SS-BL	SFTP01-0308SS-NY		8mm			
SFTP01-0310SS	SFTP01-0310SS-BL	SFTP01-0310SS-NY		10mm			
SFTP01-0312SS	SFTP01-0312SS-BL	SFTP01-0312SS-NY		12mm			
SFTP01-0316SS	SFTP01-0316SS-BL	SFTP01-0316SS-NY		16mm			
SFTP01-0320SS	SFTP01-0320SS-BL	SFTP01-0320SS-NY		20mm			
SFTP01-0325SS	SFTP01-0325SS-BL	SFTP01-0325SS-NY		25mm			
SFTP01-0350SS	SFTP01-0350SS-BL	SFTP01-0350SS-NY		50mm			
SFTP01-0406SS	SFTP01-0406SS-BL	SFTP01-0406SS-NY	M4	6mm	100		
SFTP01-0408SS	SFTP01-0408SS-BL	SFTP01-0408SS-NY		8mm			
SFTP01-0410SS	SFTP01-0410SS-BL	SFTP01-0410SS-NY		10mm			
SFTP01-0412SS	SFTP01-0412SS-BL	SFTP01-0412SS-NY		12mm			
SFTP01-0416SS	SFTP01-0416SS-BL	SFTP01-0416SS-NY		16mm			
SFTP01-0420SS	SFTP01-0420SS-BL	SFTP01-0420SS-NY		20mm			
SFTP01-0425SS	SFTP01-0425SS-BL	SFTP01-0425SS-NY		25mm			
SFTP01-0430SS	SFTP01-0430SS-BL	SFTP01-0430SS-NY		30mm			
SFTP01-0440SS	SFTP01-0440SS-BL	SFTP01-0440SS-NY	40mm	M5	100		
SFTP01-0450SS	SFTP01-0450SS-BL	SFTP01-0450SS-NY	50mm				
SFTP01-04100SS	SFTP01-04100SS-BL	SFTP01-04100SS-NY	100mm				
SFTP01-0508SS	SFTP01-0508SS-BL	SFTP01-0508SS-NY	8mm			M5	100
SFTP01-0510SS	SFTP01-0510SS-BL	SFTP01-0510SS-NY	10mm				
SFTP01-0512SS	SFTP01-0512SS-BL	SFTP01-0512SS-NY	12mm				
SFTP01-0516SS	SFTP01-0516SS-BL	SFTP01-0516SS-NY	16mm				
SFTP01-0520SS	SFTP01-0520SS-BL	SFTP01-0520SS-NY	20mm				
SFTP01-0525SS	SFTP01-0525SS-BL	SFTP01-0525SS-NY	25mm				
SFTP01-0530SS	SFTP01-0530SS-BL	SFTP01-0530SS-NY	30mm				
SFTP01-0540SS	SFTP01-0540SS-BL	SFTP01-0540SS-NY	40mm	50			
SFTP01-0550SS	SFTP01-0550SS-BL	SFTP01-0550SS-NY	50mm				
SFTP01-0560SS	SFTP01-0560SS-BL	SFTP01-0560SS-NY	60mm				
SFTP01-05100SS	SFTP01-05100SS-BL	SFTP01-05100SS-NY	100mm				

PART NUMBER			D	L	BOX QTY	
SST (A2)	SS + BLACKEN	SST + THREAD LOCK				
SFTP01-0608SS	SFTP01-0608SS-BL	SFTP01-0608SS-NY	M6	8mm	100	
SFTP01-0610SS	SFTP01-0610SS-BL	SFTP01-0610SS-NY		10mm		
SFTP01-0612SS	SFTP01-0612SS-BL	SFTP01-0612SS-NY		12mm		
SFTP01-0616SS	SFTP01-0616SS-BL	SFTP01-0616SS-NY		16mm		
SFTP01-0620SS	SFTP01-0620SS-BL	SFTP01-0620SS-NY		20mm		
SFTP01-0625SS	SFTP01-0625SS-BL	SFTP01-0625SS-NY		25mm		
SFTP01-0630SS	SFTP01-0630SS-BL	SFTP01-0630SS-NY		30mm		
SFTP01-0640SS	SFTP01-0640SS-BL	SFTP01-0640SS-NY		40mm		
SFTP01-0650SS	SFTP01-0650SS-BL	SFTP01-0650SS-NY		50mm		50
SFTP01-0660SS	SFTP01-0660SS-BL	SFTP01-0660SS-NY		60mm		
SFTP01-0670SS	SFTP01-0670SS-BL	SFTP01-0670SS-NY	70mm			
SFTP01-06100SS	SFTP01-06100SS-BL	SFTP01-06100SS-NY	100mm			

SFTP01-0810SS	SFTP01-0810SS-BL	SFTP01-0810SS-NY	M8	10mm	100	
SFTP01-0812SS	SFTP01-0812SS-BL	SFTP01-0812SS-NY		12mm		
SFTP01-0816SS	SFTP01-0816SS-BL	SFTP01-0816SS-NY		16mm		
SFTP01-0820SS	SFTP01-0820SS-BL	SFTP01-0820SS-NY		20mm		
SFTP01-0825SS	SFTP01-0825SS-BL	SFTP01-0825SS-NY		25mm		
SFTP01-0830SS	SFTP01-0830SS-BL	SFTP01-0830SS-NY		30mm		
SFTP01-0840SS	SFTP01-0840SS-BL	SFTP01-0840SS-NY		40mm		
SFTP01-0850SS	SFTP01-0850SS-BL	SFTP01-0850SS-NY		50mm		50
SFTP01-0860SS	SFTP01-0860SS-BL	SFTP01-0860SS-NY		60mm		
SFTP01-0870SS	SFTP01-0870SS-BL	SFTP01-0870SS-NY		70mm		
SFTP01-08100SS	SFTP01-08100SS-BL	SFTP01-08100SS-NY	100mm			

SFTP01-1016SS	SFTP01-1016SS-BL	SFTP01-1016SS-NY	M10	16mm	100	
SFTP01-1020SS	SFTP01-1020SS-BL	SFTP01-1020SS-NY		20mm		
SFTP01-1025SS	SFTP01-1025SS-BL	SFTP01-1025SS-NY		25mm		
SFTP01-1030SS	SFTP01-1030SS-BL	SFTP01-1030SS-NY		30mm		
SFTP01-1035SS	SFTP01-1035SS-BL	SFTP01-1035SS-NY		35mm		
SFTP01-1040SS	SFTP01-1040SS-BL	SFTP01-1040SS-NY		40mm		
SFTP01-1050SS	SFTP01-1050SS-BL	SFTP01-1050SS-NY		50mm		50
SFTP01-1060SS	SFTP01-1060SS-BL	SFTP01-1060SS-NY		60mm		
SFTP01-1070SS	SFTP01-1070SS-BL	SFTP01-1070SS-NY		70mm		

**THREAD LOCKER**

- Reliable, Power Lock
- Multiple Reuse
- Minimizes Galling / Stripping
- Cost Saving

REFER TO PAGE 38 FOR TOOLS



HP  
 TP  
 DS  
 OW  
 SM  
 TR  
 TW  
 PP  
 TN

HP  
 TP  
 DS  
 OW  
 SM  
 TR  
 TW  
 PP  
 TN



**THEFT RESISTANT SCREW (TRS)**



**TORX PIN FLAT HEAD SCREW**

MEASUREMENT: **METRIC**  
 MATERIAL: **STAINLESS STEEL A2**  
 FINISH: **PASSIVATED | BLACK | THREAD LOCK**

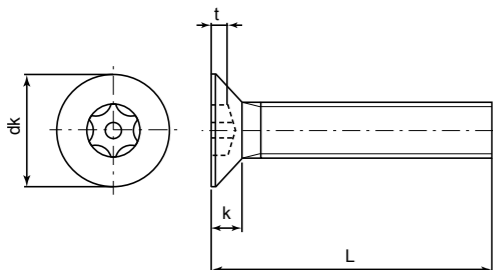

	M3	M4	M5	M6	M8
dk	6	8	10	12	16
k	1.75	2.4	2.95	3.45	4.7
s	TX10	TX20	TX25	TX30	TX40
L	6-25mm	6-50mm	8-70mm	10-70mm	16-50mm

PART NUMBER			D	L	BOX QTY	
SST (A2)	SS + BLACKEN	SST + <b>THREAD LOCK</b>				
SFTP02-0306SS	SFTP02-0306SS-BL	SFTP02-0306SS-NY	M3	6mm	100	
SFTP02-0308SS	SFTP02-0308SS-BL	SFTP02-0308SS-NY		8mm		
SFTP02-0310SS	SFTP02-0310SS-BL	SFTP02-0310SS-NY		10mm		
SFTP02-0312SS	SFTP02-0312SS-BL	SFTP02-0312SS-NY		12mm		
SFTP02-0316SS	SFTP02-0316SS-BL	SFTP02-0316SS-NY		16mm		
SFTP02-0320SS	SFTP02-0320SS-BL	SFTP02-0320SS-NY		20mm		
SFTP02-0325SS	SFTP02-0325SS-BL	SFTP02-0325SS-NY	25mm			
SFTP02-0406SS	SFTP02-0406SS-BL	SFTP02-0406SS-NY	M4	6mm	100	
SFTP02-0408SS	SFTP02-0408SS-BL	SFTP02-0408SS-NY		8mm		
SFTP02-0410SS	SFTP02-0410SS-BL	SFTP02-0410SS-NY		10mm		
SFTP02-0412SS	SFTP02-0412SS-BL	SFTP02-0412SS-NY		12mm		
SFTP02-0416SS	SFTP02-0416SS-BL	SFTP02-0416SS-NY		16mm		
SFTP02-0420SS	SFTP02-0420SS-BL	SFTP02-0420SS-NY		20mm		
SFTP02-0425SS	SFTP02-0425SS-BL	SFTP02-0425SS-NY		25mm		
SFTP02-0430SS	SFTP02-0430SS-BL	SFTP02-0430SS-NY		30mm		
SFTP02-0440SS	SFTP02-0440SS-BL	SFTP02-0440SS-NY	40mm	50		
SFTP02-0450SS	SFTP02-0450SS-BL	SFTP02-0450SS-NY	50mm			
SFTP02-0508SS	SFTP02-0508SS-BL	SFTP02-0508SS-NY	M5		8mm	100
SFTP02-0510SS	SFTP02-0510SS-BL	SFTP02-0510SS-NY			10mm	
SFTP02-0512SS	SFTP02-0512SS-BL	SFTP02-0512SS-NY			12mm	
SFTP02-0516SS	SFTP02-0516SS-BL	SFTP02-0516SS-NY		16mm		
SFTP02-0520SS	SFTP02-0520SS-BL	SFTP02-0520SS-NY		20mm		
SFTP02-0525SS	SFTP02-0525SS-BL	SFTP02-0525SS-NY		25mm		
SFTP02-0530SS	SFTP02-0530SS-BL	SFTP02-0530SS-NY		30mm		
SFTP02-0540SS	SFTP02-0540SS-BL	SFTP02-0540SS-NY		40mm		
SFTP02-0550SS	SFTP02-0550SS-BL	SFTP02-0550SS-NY		50mm		
SFTP02-0560SS	SFTP02-0560SS-BL	SFTP02-0560SS-NY		60mm		
SFTP02-0570SS	SFTP02-0570SS-BL	SFTP02-0570SS-NY	70mm			

PART NUMBER			D	L	BOX QTY	
SST (A2)	SS + BLACKEN	SST + <b>THREAD LOCK</b>				
SFTP02-0610SS	SFTP02-0610SS-BL	SFTP02-0610SS-NY	M6	10mm	100	
SFTP02-0612SS	SFTP02-0612SS-BL	SFTP02-0612SS-NY		12mm		
SFTP02-0616SS	SFTP02-0616SS-BL	SFTP02-0616SS-NY		16mm		
SFTP02-0620SS	SFTP02-0620SS-BL	SFTP02-0620SS-NY		20mm		
SFTP02-0625SS	SFTP02-0625SS-BL	SFTP02-0625SS-NY		25mm		
SFTP02-0630SS	SFTP02-0630SS-BL	SFTP02-0630SS-NY		30mm		
SFTP02-0640SS	SFTP02-0640SS-BL	SFTP02-0640SS-NY		40mm		
SFTP02-0650SS	SFTP02-0650SS-BL	SFTP02-0650SS-NY		50mm		
SFTP02-0660SS	SFTP02-0660SS-BL	SFTP02-0660SS-NY		60mm		50
SFTP02-0670SS	SFTP02-0670SS-BL	SFTP02-0670SS-NY		70mm		
SFTP02-0816SS	SFTP02-0816SS-BL	SFTP02-0816SS-NY	M8	16mm	100	
SFTP02-0820SS	SFTP02-0820SS-BL	SFTP02-0820SS-NY		20mm		
SFTP02-0825SS	SFTP02-0825SS-BL	SFTP02-0825SS-NY		25mm		
SFTP02-0830SS	SFTP02-0830SS-BL	SFTP02-0830SS-NY		30mm		
SFTP02-0840SS	SFTP02-0840SS-BL	SFTP02-0840SS-NY		40mm		
SFTP02-0850SS	SFTP02-0850SS-BL	SFTP02-0850SS-NY		50mm		

**THREAD LOCKER**

- Reliable, Power Lock
- Multiple Reuse
- Minimizes Galling / Stripping
- Cost Saving

REFER TO PAGE 38 FOR TOOLS





**THEFT RESISTANT SCREW (TRS)**



**TORX PIN BUTTON HEAD SHEET METAL SCREW  
TYPE AB**

MEASUREMENT: **METRIC**  
MATERIAL: **STAINLESS STEEL A2**  
FINISH: **PASSIVATED | BLACK**

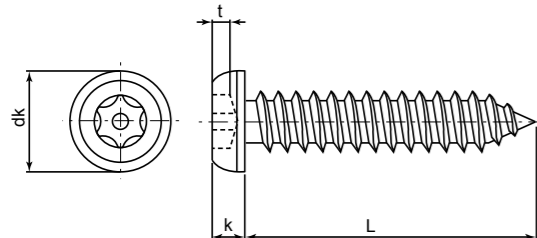

	3.5	4.2	4.8	5.5	6.3
dk	5.7	7.6	9.5	9.9	10.5
k	1.65	2.2	2.75	2.9	3.3
s	TX10	TX15	TX25	TX27	TX27

PART NUMBER		D	L	BOX QTY
SST (A2)	SS + BLACKEN			
SFTP03-3513SS	SFTP03-3513SS-BL	3.5	13	100
SFTP03-3519SS	SFTP03-3519SS-BL		19	
SFTP03-3525SS	SFTP03-3525SS-BL		25	
SFTP03-3532SS	SFTP03-3532SS-BL		32	
SFTP03-3538SS	SFTP03-3538SS-BL		38	
SFTP03-4213SS	SFTP03-4213SS-BL	4.2	13	100
SFTP03-4219SS	SFTP03-4219SS-BL		19	
SFTP03-4225SS	SFTP03-4225SS-BL		25	
SFTP03-4232SS	SFTP03-4232SS-BL		32	
SFTP03-4238SS	SFTP03-4238SS-BL	4.8	38	100
SFTP03-4813SS	SFTP03-4813SS-BL		13	
SFTP03-4819SS	SFTP03-4819SS-BL		19	
SFTP03-4825SS	SFTP03-4825SS-BL		25	
SFTP03-4832SS	SFTP03-4832SS-BL		32	
SFTP03-4838SS	SFTP03-4838SS-BL	38		
SFTP03-4850SS	SFTP03-4850SS-BL			

PART NUMBER		D	L	BOX QTY	
SST (A2)	SS + BLACKEN				
SFTP03-5513SS	SFTP03-5513SS-BL	5.5	13	100	
SFTP03-5519SS	SFTP03-5519SS-BL		19		
SFTP03-5525SS	SFTP03-5525SS-BL		25		
SFTP03-5532SS	SFTP03-5532SS-BL		32		
SFTP03-5538SS	SFTP03-5538SS-BL		38		
SFTP03-5550SS	SFTP03-5550SS-BL	50			
SFTP03-5563SS	SFTP03-5563SS-BL				63
SFTP03-5575SS	SFTP03-5575SS-BL				75
SFTP03-6313SS	SFTP03-6313SS-BL	6.3	13	100	
SFTP03-6319SS	SFTP03-6319SS-BL		19		
SFTP03-6325SS	SFTP03-6325SS-BL		25		
SFTP03-6332SS	SFTP03-6332SS-BL		32		
SFTP03-6338SS	SFTP03-6338SS-BL		38		
SFTP03-6350SS	SFTP03-6350SS-BL	50			

**THEFT RESISTANT SCREW (TRS)**



**TORX PIN FLAT HEAD SHEET METAL SCREW  
TYPE AB**

MEASUREMENT: **METRIC**  
MATERIAL: **STAINLESS STEEL A2**  
FINISH: **PASSIVATED | BLACK**

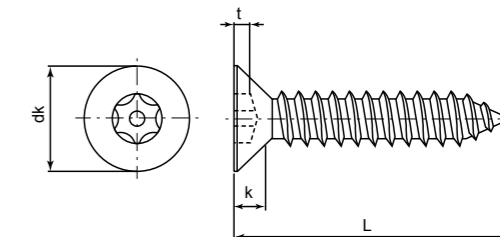

	3.5	4.2	4.8	5.5	6.3
dk	6.8	8.1	9.5	10.8	12.4
k	2.15	2.6	3.15	3.55	4
s	TX15	TX20	TX25	TX27	TX30

PART NUMBER		D	L	BOX QTY		
SST (A2)	SS + BLACKEN					
SFTP04-3513SS	SFTP04-3513SS-BL	3.5	13	100		
SFTP04-3516SS	SFTP04-3516SS-BL		16			
SFTP04-3519SS	SFTP04-3519SS-BL		19			
SFTP04-3525SS	SFTP04-3525SS-BL		25			
SFTP04-3532SS	SFTP04-3532SS-BL		32			
SFTP04-3538SS	SFTP04-3538SS-BL	38				
SFTP04-4213SS	SFTP04-4213SS-BL	4.2	13	100		
SFTP04-4216SS	SFTP04-4216SS-BL		16			
SFTP04-4219SS	SFTP04-4219SS-BL		19			
SFTP04-4225SS	SFTP04-4225SS-BL		25			
SFTP04-4232SS	SFTP04-4232SS-BL	32				
SFTP04-4238SS	SFTP04-4238SS-BL				38	
SFTP04-4813SS	SFTP04-4813SS-BL	4.8	13	100		
SFTP04-4816SS	SFTP04-4816SS-BL		16			
SFTP04-4819SS	SFTP04-4819SS-BL		19			
SFTP04-4825SS	SFTP04-4825SS-BL		25			
SFTP04-4832SS	SFTP04-4832SS-BL		32			
SFTP04-4838SS	SFTP04-4838SS-BL		38			
SFTP04-4850SS	SFTP04-4850SS-BL		50			

PART NUMBER		D	L	BOX QTY	
SST (A2)	SS + BLACKEN				
SFTP04-5513SS	SFTP04-5513SS-BL	5.5	13	100	
SFTP04-5516SS	SFTP04-5516SS-BL		16		
SFTP04-5519SS	SFTP04-5519SS-BL		19		
SFTP04-5525SS	SFTP04-5525SS-BL		25		
SFTP04-5532SS	SFTP04-5532SS-BL		32		
SFTP04-5538SS	SFTP04-5538SS-BL	50			
SFTP04-5550SS	SFTP04-5550SS-BL				50
SFTP04-5563SS	SFTP04-5563SS-BL				63
SFTP04-5575SS	SFTP04-5575SS-BL	75			
SFTP04-6316SS	SFTP04-6316SS-BL	6.3	16	100	
SFTP04-6319SS	SFTP04-6319SS-BL		19		
SFTP04-6325SS	SFTP04-6325SS-BL		25		
SFTP04-6332SS	SFTP04-6332SS-BL		32		
SFTP04-6338SS	SFTP04-6338SS-BL		38		
SFTP04-6350SS	SFTP04-6350SS-BL	50			

REFER TO PAGE 38 FOR TOOLS



- HP
- TP
- DS
- OW
- SM
- TR
- TW
- PP
- TN

- HP
- TP
- DS
- OW
- SM
- TR
- TW
- PP
- TN



**THEFT RESISTANT SCREW (TRS)**

**DRILLED SPANNER PAN HEAD MACHINE SCREW**

MEASUREMENT: **METRIC**  
 MATERIAL: **STAINLESS STEEL A2**  
 FINISH: **PASSIVATED | BLACK | THREAD LOCK**

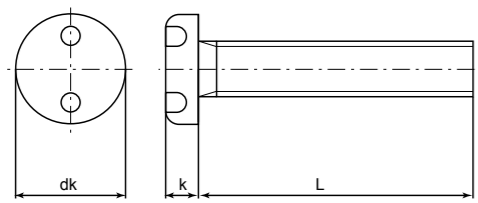

	M3	M4	M5	M6
dk	5.7	8	10	12
k	1.65	2.2	2.75	3.3
Drive Size	SP4	SP8	SP10	SP14
L	6-20mm	6-25mm	10-30mm	10-40mm

PART NUMBER			D	L	BOX QTY
SST (A2)	SS + BLACKEN	SST + <b>THREAD LOCK</b>			
SFDS01-0306SS	SFDS01-0306SS-BL	SFDS01-0306SS-NY	M3	6mm	100
SFDS01-0308SS	SFDS01-0308SS-BL	SFDS01-0308SS-NY		8mm	
SFDS01-0310SS	SFDS01-0310SS-BL	SFDS01-0310SS-NY		10mm	
SFDS01-0312SS	SFDS01-0312SS-BL	SFDS01-0312SS-NY		12mm	
SFDS01-0316SS	SFDS01-0316SS-BL	SFDS01-0316SS-NY		16mm	
SFDS01-0320SS	SFDS01-0320SS-BL	SFDS01-0320SS-NY		20mm	

SFDS01-0406SS	SFDS01-0406SS-BL	SFDS01-0406SS-NY	M4	6mm	100
SFDS01-0408SS	SFDS01-0408SS-BL	SFDS01-0408SS-NY		8mm	
SFDS01-0410SS	SFDS01-0410SS-BL	SFDS01-0410SS-NY		10mm	
SFDS01-0412SS	SFDS01-0412SS-BL	SFDS01-0412SS-NY		12mm	
SFDS01-0416SS	SFDS01-0416SS-BL	SFDS01-0416SS-NY		16mm	
SFDS01-0420SS	SFDS01-0420SS-BL	SFDS01-0420SS-NY		20mm	
SFDS01-0425SS	SFDS01-0425SS-BL	SFDS01-0425SS-NY		25mm	

SFDS01-0510SS	SFDS01-0510SS-BL	SFDS01-0510SS-NY	M5	10mm	100
SFDS01-0512SS	SFDS01-0512SS-BL	SFDS01-0512SS-NY		12mm	
SFDS01-0516SS	SFDS01-0516SS-BL	SFDS01-0516SS-NY		16mm	
SFDS01-0520SS	SFDS01-0520SS-BL	SFDS01-0520SS-NY		20mm	
SFDS01-0525SS	SFDS01-0525SS-BL	SFDS01-0525SS-NY		25mm	
SFDS01-0530SS	SFDS01-0530SS-BL	SFDS01-0530SS-NY		30mm	

PART NUMBER			D	L	BOX QTY
SST (A2)	SS + BLACKEN	SST + <b>THREAD LOCK</b>			
SFDS01-0610SS	SFDS01-0610SS-BL	SFDS01-0610SS-NY	M6	10mm	100
SFDS01-0612SS	SFDS01-0612SS-BL	SFDS01-0612SS-NY		12mm	
SFDS01-0616SS	SFDS01-0616SS-BL	SFDS01-0616SS-NY		16mm	
SFDS01-0620SS	SFDS01-0620SS-BL	SFDS01-0620SS-NY		20mm	
SFDS01-0625SS	SFDS01-0625SS-BL	SFDS01-0625SS-NY		25mm	
SFDS01-0630SS	SFDS01-0630SS-BL	SFDS01-0630SS-NY		30mm	
SFDS01-0640SS	SFDS01-0640SS-BL	SFDS01-0640SS-NY		40mm	

**THREAD LOCKER**

- Reliable, Power Lock
- Multiple Reuse
- Minimizes Galling / Stripping
- Cost Saving

REFER TO PAGE 38 FOR TOOLS



HP  
 TP  
 DS  
 OW  
 SM  
 TR  
 TW  
 PP  
 TN

HP  
 TP  
 DS  
 OW  
 SM  
 TR  
 TW  
 PP  
 TN



**THEFT RESISTANT SCREW (TRS)**



**DRILLED SPANNER FLAT MACHINE HEAD SCREW**

MEASUREMENT: METRIC  
 MATERIAL: STAINLESS STEEL A2  
 FINISH: PASSIVATED | BLACK | THREAD LOCK

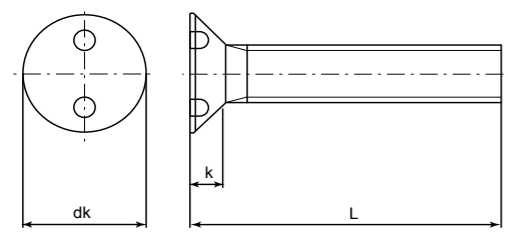

	M3	M4	M5	M6
dk	6	8.4	10.4	12.4
k	1.75	2.4	2.95	3.45
Drive Size	SP4	SP8	SP10	SP14
L	6-30mm	10-50mm	12-50mm	12-50mm

PART NUMBER			D	L	BOX QTY
SST (A2)	SS + BLACKEN	SST + <b>THREAD LOCK</b>			
SFDS02-0306SS	SFDS02-0306SS-BL	SFDS02-0306SS-NY	M3	6mm	100
SFDS02-0308SS	SFDS02-0308SS-BL	SFDS02-0308SS-NY		8mm	
SFDS02-0310SS	SFDS02-0310SS-BL	SFDS02-0310SS-NY		10mm	
SFDS02-0312SS	SFDS02-0312SS-BL	SFDS02-0312SS-NY		12mm	
SFDS02-0316SS	SFDS02-0316SS-BL	SFDS02-0316SS-NY		16mm	
SFDS02-0320SS	SFDS02-0320SS-BL	SFDS02-0320SS-NY		20mm	
SFDS02-0325SS	SFDS02-0325SS-BL	SFDS02-0325SS-NY		25mm	
SFDS02-0330SS	SFDS02-0330SS-BL	SFDS02-0330SS-NY		30mm	

SFDS02-0410SS	SFDS02-0410SS-BL	SFDS02-0410SS-NY	M4	10mm	100
SFDS02-0412SS	SFDS02-0412SS-BL	SFDS02-0412SS-NY		12mm	
SFDS02-0416SS	SFDS02-0416SS-BL	SFDS02-0416SS-NY		16mm	
SFDS02-0420SS	SFDS02-0420SS-BL	SFDS02-0420SS-NY		20mm	
SFDS02-0425SS	SFDS02-0425SS-BL	SFDS02-0425SS-NY		25mm	
SFDS02-0430SS	SFDS02-0430SS-BL	SFDS02-0430SS-NY		30mm	
SFDS02-0435SS	SFDS02-0435SS-BL	SFDS02-0435SS-NY		35mm	
SFDS02-0440SS	SFDS02-0440SS-BL	SFDS02-0440SS-NY		40mm	
SFDS02-0450SS	SFDS02-0450SS-BL	SFDS02-0450SS-NY		50mm	

SFDS02-0512SS	SFDS02-0512SS-BL	SFDS02-0512SS-NY	M5	12mm	100
SFDS02-0516SS	SFDS02-0516SS-BL	SFDS02-0516SS-NY		16mm	
SFDS02-0520SS	SFDS02-0520SS-BL	SFDS02-0520SS-NY		20mm	
SFDS02-0525SS	SFDS02-0525SS-BL	SFDS02-0525SS-NY		25mm	
SFDS02-0530SS	SFDS02-0530SS-BL	SFDS02-0530SS-NY		30mm	
SFDS02-0535SS	SFDS02-0535SS-BL	SFDS02-0535SS-NY		35mm	
SFDS02-0540SS	SFDS02-0540SS-BL	SFDS02-0540SS-NY		40mm	
SFDS02-0550SS	SFDS02-0550SS-BL	SFDS02-0550SS-NY		50mm	

PART NUMBER			D	L	BOX QTY
SST (A2)	SS + BLACKEN	SST + <b>THREAD LOCK</b>			
SFDS02-0612SS	SFDS02-0612SS-BL	SFDS02-0612SS-NY	M6	12mm	100
SFDS02-0616SS	SFDS02-0616SS-BL	SFDS02-0616SS-NY		16mm	
SFDS02-0620SS	SFDS02-0620SS-BL	SFDS02-0620SS-NY		20mm	
SFDS02-0625SS	SFDS02-0625SS-BL	SFDS02-0625SS-NY		25mm	
SFDS02-0630SS	SFDS02-0630SS-BL	SFDS02-0630SS-NY		30mm	
SFDS02-0635SS	SFDS02-0635SS-BL	SFDS02-0635SS-NY		35mm	
SFDS02-0640SS	SFDS02-0640SS-BL	SFDS02-0640SS-NY		40mm	
SFDS02-0650SS	SFDS02-0650SS-BL	SFDS02-0650SS-NY		50mm	

**THREAD LOCKER**

- Reliable, Power Lock
- Multiple Reuse
- Minimizes Galling / Stripping
- Cost Saving

REFER TO PAGE 38 FOR TOOLS



HP  
 TP  
 DS  
 OW  
 SM  
 TR  
 TW  
 PP  
 TN

HP  
 TP  
 DS  
 OW  
 SM  
 TR  
 TW  
 PP  
 TN

THEFT RESISTANT SCREW (TRS)



DRILLED SPANNER PAN HEAD SHEET METAL SCREW TYPE AB

MEASUREMENT: METRIC
MATERIAL: STAINLESS STEEL A2
FINISH: PASSIVATED | BLACK



Table with 7 columns (dk, k, Drive Size, L) and 6 rows (2.9, 3.5, 4.2, 4.8, 5.5, 6.3) for dimensions and drive sizes.

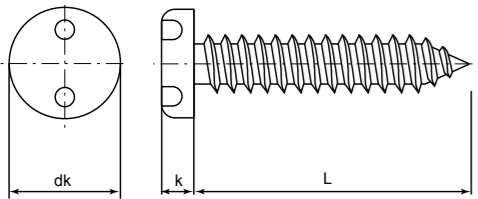

THEFT RESISTANT SCREW (TRS)



DRILLED SPANNER FLAT HEAD SHEET METAL SCREW TYPE AB

MEASUREMENT: METRIC
MATERIAL: STAINLESS STEEL A2
FINISH: PASSIVATED | BLACK



Table with 7 columns (dk, k, Drive Size, L) and 6 rows (2.9, 3.5, 4.2, 4.8, 5.5, 6.3) for dimensions and drive sizes.

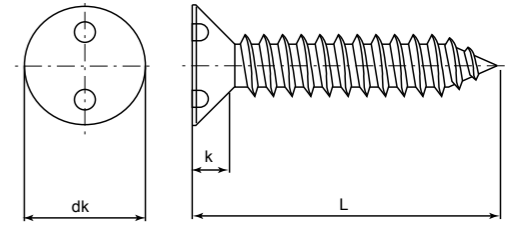

Main table for DS03 listing part numbers (SST A2 and SS + BLACKEN), dimensions (D, L), and box quantities for various sizes.

Main table for DS03 listing part numbers (SST A2 and SS + BLACKEN), dimensions (D, L), and box quantities for various sizes.

Main table for DS04 listing part numbers (SST A2 and SS + BLACKEN), dimensions (D, L), and box quantities for various sizes.

Main table for DS04 listing part numbers (SST A2 and SS + BLACKEN), dimensions (D, L), and box quantities for various sizes.

REFER TO PAGE 38 FOR TOOLS





**THEFT RESISTANT SCREW (TRS)**



**DRILLED SPANNER RAISED FLAT HEAD SHEET METAL SCREW**

MEASUREMENT: **METRIC**  
 MATERIAL: **STAINLESS STEEL A2**  
 FINISH: **PASSIVATED | BLACK**

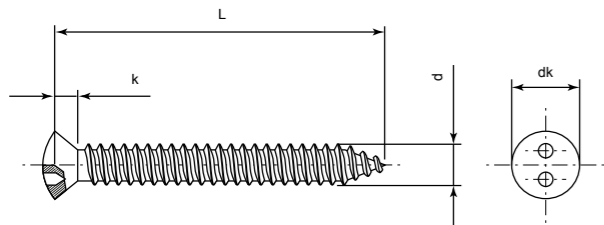

	3.5	4.2	4.8
dk	5.7	7.6	9.5
k	1.65	2.2	2.75
Drive Size	SP6	SP8	SP10
L	13-50mm		

PART NUMBER		D	L	BOX QTY
SST (A2)	SS + BLACKEN			
SFDS05-3513SS	SFDS05-3513SS-BL	3.5	13	100
SFDS05-3516SS	SFDS05-3516SS-BL		16	
SFDS05-3519SS	SFDS05-3519SS-BL		19	
SFDS05-3525SS	SFDS05-3525SS-BL		25	
SFDS05-3532SS	SFDS05-3532SS-BL		32	
SFDS05-3538SS	SFDS05-3538SS-BL		38	
SFDS05-3550SS	SFDS05-3550SS-BL		50	

SFDS05-4213SS	SFDS05-4213SS-BL	4.2	13	100
SFDS05-4216SS	SFDS05-4216SS-BL		16	
SFDS05-4219SS	SFDS05-4219SS-BL		19	
SFDS05-4225SS	SFDS05-4225SS-BL		25	
SFDS05-4232SS	SFDS05-4232SS-BL		32	
SFDS05-4238SS	SFDS05-4238SS-BL		38	
SFDS05-4250SS	SFDS05-4250SS-BL		50	

SFDS05-4813SS	SFDS05-4813SS-BL	4.8	13	100
SFDS05-4816SS	SFDS05-4816SS-BL		16	
SFDS05-4819SS	SFDS05-4819SS-BL		19	
SFDS05-4825SS	SFDS05-4825SS-BL		25	
SFDS05-4832SS	SFDS05-4832SS-BL		32	
SFDS05-4838SS	SFDS05-4838SS-BL		38	
SFDS05-4850SS	SFDS05-4850SS-BL		50	

**THEFT RESISTANT SCREW (TRS)**



**DRILLED SPANNER NUT REVERSIBLE**

MEASUREMENT: **METRIC**  
 MATERIAL: **STAINLESS STEEL A2**  
 FINISH: **PASSIVATED | BLACK | THREAD LOCK**



	M5	M6	M8	M10	M12
HT	6.35	6.35	6.35	6.35	6.35
OD	25.4	25.4	25.4	25.4	29
Drive Size	Type #1			Type #2	

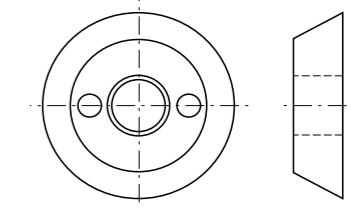

PART NUMBER			D	BOX QTY
SST (A2)	SS + BLACKEN	SST + <b>THREAD LOCK</b>		
SFDS06-05SS	SFDS06-05SS-BL	SFDS06-05SS-NY	M5	10
SFDS06-06SS	SFDS06-06SS-BL	SFDS06-06SS-NY	M6	10
SFDS06-08SS	SFDS06-08SS-BL	SFDS06-08SS-NY	M8	10
SFDS06-10SS	SFDS06-10SS-BL	SFDS06-10SS-NY	M10	10
SFDS06-12SS	SFDS06-12SS-BL	SFDS06-12SS-NY	M12	10

**THREAD LOCKER**

- Reliable, Power Lock
- Multiple Reuse
- Minimizes Galling / Stripping
- Cost Saving

REFER TO PAGE 38 FOR TOOLS



**THEFT RESISTANT SCREW (TRS)**



**ONE WAY ROUND HEAD MACHINE SCREW**

MEASUREMENT: METRIC  
 MATERIAL: STAINLESS STEEL A2  
 FINISH: PASSIVATED | BLACK | THREAD LOCK

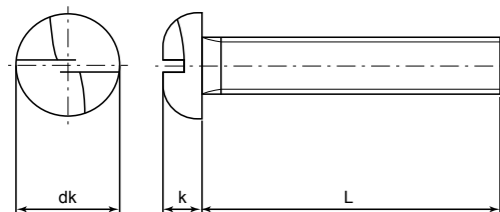

	M3	M4	M5	M6	M8
dk	5.5	7.5	9.2	12	13
k	2	3	3.5	4.4	4.8
L	6-16mm	8-50mm	8-70mm	10-70mm	10-70mm

PART NUMBER			D	L	BOX QTY
SST (A2)	SS + BLACKEN	SST + THREAD LOCK			
SFOW01-0306SS	SFOW01-0306SS-BL	SFOW01-0306SS-NY	M3	6mm	100
SFOW01-0308SS	SFOW01-0308SS-BL	SFOW01-0308SS-NY		8mm	
SFOW01-0310SS	SFOW01-0310SS-BL	SFOW01-0310SS-NY		10mm	
SFOW01-0312SS	SFOW01-0312SS-BL	SFOW01-0312SS-NY		12mm	
SFOW01-0316SS	SFOW01-0316SS-BL	SFOW01-0316SS-NY		16mm	
SFOW01-0408SS	SFOW01-0408SS-BL	SFOW01-0408SS-NY		M4	
SFOW01-0410SS	SFOW01-0410SS-BL	SFOW01-0410SS-NY	10mm		
SFOW01-0412SS	SFOW01-0412SS-BL	SFOW01-0412SS-NY	12mm		
SFOW01-0416SS	SFOW01-0416SS-BL	SFOW01-0416SS-NY	16mm		
SFOW01-0420SS	SFOW01-0420SS-BL	SFOW01-0420SS-NY	20mm		
SFOW01-0425SS	SFOW01-0425SS-BL	SFOW01-0425SS-NY	25mm		
SFOW01-0430SS	SFOW01-0430SS-BL	SFOW01-0430SS-NY	30mm		
SFOW01-0435SS	SFOW01-0435SS-BL	SFOW01-0435SS-NY	35mm		
SFOW01-0440SS	SFOW01-0440SS-BL	SFOW01-0440SS-NY	40mm		
SFOW01-0445SS	SFOW01-0445SS-BL	SFOW01-0445SS-NY	45mm		
SFOW01-0450SS	SFOW01-0450SS-BL	SFOW01-0450SS-NY	50mm		
SFOW01-0508SS	SFOW01-0508SS-BL	SFOW01-0508SS-NY	M5	8mm	100
SFOW01-0510SS	SFOW01-0510SS-BL	SFOW01-0510SS-NY		10mm	
SFOW01-0512SS	SFOW01-0512SS-BL	SFOW01-0512SS-NY		12mm	
SFOW01-0516SS	SFOW01-0516SS-BL	SFOW01-0516SS-NY		16mm	
SFOW01-0520SS	SFOW01-0520SS-BL	SFOW01-0520SS-NY		20mm	
SFOW01-0525SS	SFOW01-0525SS-BL	SFOW01-0525SS-NY		25mm	
SFOW01-0530SS	SFOW01-0530SS-BL	SFOW01-0530SS-NY		30mm	
SFOW01-0535SS	SFOW01-0535SS-BL	SFOW01-0535SS-NY		35mm	
SFOW01-0540SS	SFOW01-0540SS-BL	SFOW01-0540SS-NY		40mm	
SFOW01-0545SS	SFOW01-0545SS-BL	SFOW01-0545SS-NY		45mm	
SFOW01-0550SS	SFOW01-0550SS-BL	SFOW01-0550SS-NY		50mm	
SFOW01-0560SS	SFOW01-0560SS-BL	SFOW01-0560SS-NY		60mm	
SFOW01-0570SS	SFOW01-0570SS-BL	SFOW01-0570SS-NY		70mm	

PART NUMBER			D	L	BOX QTY		
SST (A2)	SS + BLACKEN	SST + THREAD LOCK					
SFOW01-0610SS	SFOW01-0610SS-BL	SFOW01-0610SS-NY	M6	10mm	100		
SFOW01-0612SS	SFOW01-0612SS-BL	SFOW01-0612SS-NY		12mm			
SFOW01-0616SS	SFOW01-0616SS-BL	SFOW01-0616SS-NY		16mm			
SFOW01-0620SS	SFOW01-0620SS-BL	SFOW01-0620SS-NY		20mm			
SFOW01-0625SS	SFOW01-0625SS-BL	SFOW01-0625SS-NY		25mm			
SFOW01-0630SS	SFOW01-0630SS-BL	SFOW01-0630SS-NY		30mm			
SFOW01-0635SS	SFOW01-0635SS-BL	SFOW01-0635SS-NY		35mm			
SFOW01-0640SS	SFOW01-0640SS-BL	SFOW01-0640SS-NY		40mm			
SFOW01-0645SS	SFOW01-0645SS-BL	SFOW01-0645SS-NY		45mm			
SFOW01-0650SS	SFOW01-0650SS-BL	SFOW01-0650SS-NY		50mm			
SFOW01-0660SS	SFOW01-0660SS-BL	SFOW01-0660SS-NY		60mm			
SFOW01-0670SS	SFOW01-0670SS-BL	SFOW01-0670SS-NY		70mm			
SFOW01-0810SS	SFOW01-0810SS-BL	SFOW01-0810SS-NY		M8		10mm	100
SFOW01-0812SS	SFOW01-0812SS-BL	SFOW01-0812SS-NY				12mm	
SFOW01-0816SS	SFOW01-0816SS-BL	SFOW01-0816SS-NY	16mm				
SFOW01-0820SS	SFOW01-0820SS-BL	SFOW01-0820SS-NY	20mm				
SFOW01-0825SS	SFOW01-0825SS-BL	SFOW01-0825SS-NY	25mm				
SFOW01-0830SS	SFOW01-0830SS-BL	SFOW01-0830SS-NY	30mm				
SFOW01-0835SS	SFOW01-0835SS-BL	SFOW01-0835SS-NY	35mm				
SFOW01-0840SS	SFOW01-0840SS-BL	SFOW01-0840SS-NY	40mm				
SFOW01-0845SS	SFOW01-0845SS-BL	SFOW01-0845SS-NY	45mm				
SFOW01-0850SS	SFOW01-0850SS-BL	SFOW01-0850SS-NY	50mm				
SFOW01-0860SS	SFOW01-0860SS-BL	SFOW01-0860SS-NY	60mm				
SFOW01-0870SS	SFOW01-0870SS-BL	SFOW01-0870SS-NY	70mm				

**THREAD LOCKER**

- Reliable, Power Lock
- Multiple Reuse
- Minimizes Galling / Stripping
- Cost Saving

REFER TO PAGE 38 FOR TOOLS

BACK

HP  
 TP  
 DS  
 OW  
 SM  
 TR  
 TW  
 PP  
 TN

HP  
 TP  
 DS  
 OW  
 SM  
 TR  
 TW  
 PP  
 TN



**THEFT RESISTANT SCREW (TRS)**

**ONE WAY ROUND HEAD MACHINE SCREW**



MEASUREMENT: **METRIC**  
 MATERIAL: **STAINLESS STEEL A2**  
 FINISH: **PASSIVATED | BLACK**

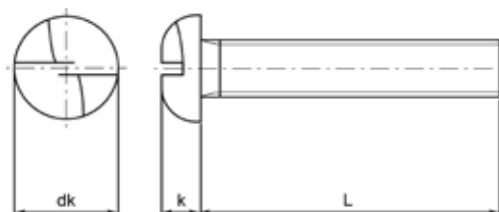

	2.9	3.5	4.2	4.8	5.5	6.3
dk	5.4	6.5	7.3	9.1	10.4	12
k	2.2	2.6	3	3.5	3.9	4.4
L	9.5-19mm	13-32mm	13-38mm	13-50mm	13-63mm	13-75mm

PART NUMBER		D	L	BOX QTY	PART NUMBER		D	L	BOX QTY
SST (A2)	SS + BLACKEN				SST (A2)	SS + BLACKEN			
SFOW03-29095SS	SFOW03-29095SS-BL	2.9	9.5	100	SFOW03-5513SS	SFOW03-5513SS-BL	5.5	13	100
SFOW03-2913SS	SFOW03-2913SS-BL		13		SFOW03-5516SS	SFOW03-5516SS-BL		16	
SFOW03-2916SS	SFOW03-2916SS-BL		16		SFOW03-5519SS	SFOW03-5519SS-BL		19	
SFOW03-2919SS	SFOW03-2919SS-BL		19		SFOW03-5525SS	SFOW03-5525SS-BL		25	
SFOW03-3513SS	SFOW03-3513SS-BL	3.5	13	100	SFOW03-5532SS	SFOW03-5532SS-BL	6.3	32	100
SFOW03-3516SS	SFOW03-3516SS-BL		16		SFOW03-5538SS	SFOW03-5538SS-BL		38	
SFOW03-3519SS	SFOW03-3519SS-BL		19		SFOW03-5545SS	SFOW03-5545SS-BL		45	
SFOW03-3525SS	SFOW03-3525SS-BL		25		SFOW03-5550SS	SFOW03-5550SS-BL		50	
SFOW03-3532SS	SFOW03-3532SS-BL		32		SFOW03-5563SS	SFOW03-5563SS-BL		63	
SFOW03-4213SS	SFOW03-4213SS-BL	4.2	13	100	SFOW03-6313SS	SFOW03-6313SS-BL	6.3	13	100
SFOW03-4216SS	SFOW03-4216SS-BL		16		SFOW03-6316SS	SFOW03-6316SS-BL		16	
SFOW03-4219SS	SFOW03-4219SS-BL		19		SFOW03-6319SS	SFOW03-6319SS-BL		19	
SFOW03-4225SS	SFOW03-4225SS-BL		25		SFOW03-6325SS	SFOW03-6325SS-BL		25	
SFOW03-4232SS	SFOW03-4232SS-BL		32		SFOW03-6332SS	SFOW03-6332SS-BL		32	
SFOW03-4238SS	SFOW03-4238SS-BL		38		SFOW03-6338SS	SFOW03-6338SS-BL		38	
SFOW03-4813SS	SFOW03-4813SS-BL	4.8	13	100	SFOW03-6345SS	SFOW03-6345SS-BL	6.3	45	100
SFOW03-4816SS	SFOW03-4816SS-BL		16		SFOW03-6350SS	SFOW03-6350SS-BL		50	
SFOW03-4819SS	SFOW03-4819SS-BL		19		SFOW03-6363SS	SFOW03-6363SS-BL		63	
SFOW03-4825SS	SFOW03-4825SS-BL		25		SFOW03-6375SS	SFOW03-6375SS-BL		75	
SFOW03-4832SS	SFOW03-4832SS-BL		32				45		
SFOW03-4838SS	SFOW03-4838SS-BL		38				50		
SFOW03-4845SS	SFOW03-4845SS-BL		45				63		
SFOW03-4850SS	SFOW03-4850SS-BL		50				75		

**THEFT RESISTANT SCREW (TRS)**

**ONE WAY RAISED FLAT HEAD SHEET METAL SCREW**

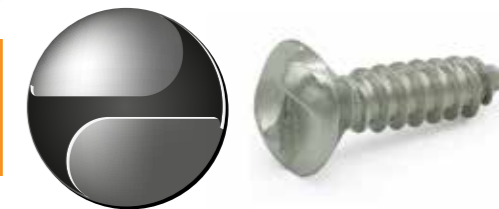

MEASUREMENT: **METRIC**  
 MATERIAL: **STAINLESS STEEL A2**  
 FINISH: **PASSIVATED | BLACK**



	3.5	4.2	4.8
dk	5.7	7.6	9.5
k	1.65	2.2	2.75
Drive Size	SP6	SP8	SP10
L	13-50mm		

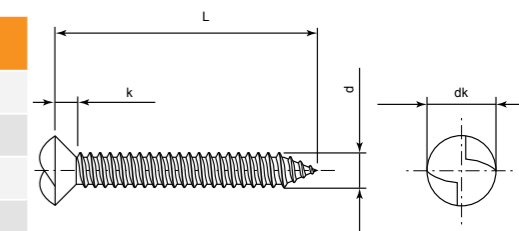

PART NUMBER		D	L	BOX QTY
SST (A2)	SS + BLACKEN			
SFOW04-3513SS	SFOW04-3513SS-BL	3.5	13	100
SFOW04-3516SS	SFOW04-3516SS-BL		16	
SFOW04-3519SS	SFOW04-3519SS-BL		19	
SFOW04-3525SS	SFOW04-3525SS-BL		25	
SFOW04-3532SS	SFOW04-3532SS-BL		32	
SFOW04-3538SS	SFOW04-3538SS-BL		38	
SFOW04-3550SS	SFOW04-3550SS-BL		50	
SFOW04-4213SS	SFOW04-4213SS-BL	4.2	13	100
SFOW04-4216SS	SFOW04-4216SS-BL		16	
SFOW04-4219SS	SFOW04-4219SS-BL		19	
SFOW04-4225SS	SFOW04-4225SS-BL		25	
SFOW04-4232SS	SFOW04-4232SS-BL		32	
SFOW04-4238SS	SFOW04-4238SS-BL		38	
SFOW04-4250SS	SFOW04-4250SS-BL		50	
SFOW04-4813SS	SFOW04-4813SS-BL	4.8	13	100
SFOW04-4816SS	SFOW04-4816SS-BL		16	
SFOW04-4819SS	SFOW04-4819SS-BL		19	
SFOW04-4825SS	SFOW04-4825SS-BL		25	
SFOW04-4832SS	SFOW04-4832SS-BL		32	
SFOW04-4838SS	SFOW04-4838SS-BL		38	
SFOW04-4850SS	SFOW04-4850SS-BL		50	

REFER TO PAGE 38 FOR TOOLS



**THEFT RESISTANT SCREW (TRS)**

**SYSTEM MICRO EXTERNAL TYPE A MACHINE SCREW**

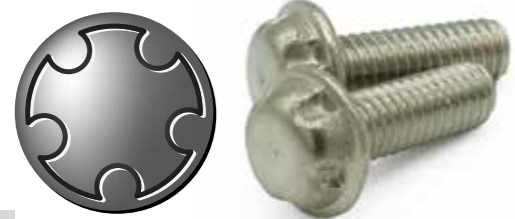

MEASUREMENT: METRIC  
 MATERIAL: STAINLESS STEEL A2  
 FINISH: PASSIVATED | BLACK | THREAD LOCK

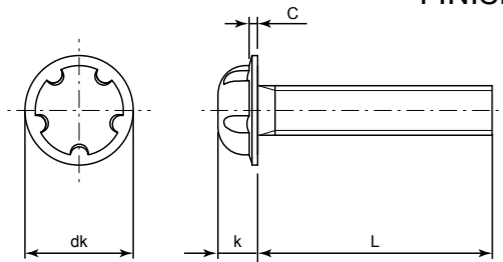

	M2	M2.3	M2.5	M2.6
dk	4.6	4.6	5.6	5.6
k	1.46	1.46	2.03	2.03
Drive Size	SM-1	SM-1	SM-2	SM-2
L	4-16mm		4-20mm	

PART NUMBER			D	L	BOX QTY
SST (A2)	SS + BLACKEN	SST + THREAD LOCK			
SFSM01-0204SS	SFSM01-0204SS-BL	SFSM01-0204SS-NY	M2	4mm	100
SFSM01-0206SS	SFSM01-0206SS-BL	SFSM01-0206SS-NY		6mm	
SFSM01-0208SS	SFSM01-0208SS-BL	SFSM01-0208SS-NY		8mm	
SFSM01-0210SS	SFSM01-0210SS-BL	SFSM01-0210SS-NY		10mm	
SFSM01-0212SS	SFSM01-0212SS-BL	SFSM01-0212SS-NY		12mm	
SFSM01-0216SS	SFSM01-0216SS-BL	SFSM01-0216SS-NY		16mm	
SFSM01-02304SS	SFSM01-02304SS-BL	SFSM01-02304SS-NY	M2.3	4mm	100
SFSM01-02306SS	SFSM01-02306SS-BL	SFSM01-02306SS-NY		6mm	
SFSM01-02308SS	SFSM01-02308SS-BL	SFSM01-02308SS-NY		8mm	
SFSM01-02310SS	SFSM01-02310SS-BL	SFSM01-02310SS-NY		10mm	
SFSM01-02312SS	SFSM01-02312SS-BL	SFSM01-02312SS-NY		12mm	
SFSM01-02316SS	SFSM01-02316SS-BL	SFSM01-02316SS-NY		16mm	
SFSM01-02504SS	SFSM01-02504SS-BL	SFSM01-02504SS-NY	M2.5	4mm	100
SFSM01-02506SS	SFSM01-02506SS-BL	SFSM01-02506SS-NY		6mm	
SFSM01-02508SS	SFSM01-02508SS-BL	SFSM01-02508SS-NY		8mm	
SFSM01-02510SS	SFSM01-02510SS-BL	SFSM01-02510SS-NY		10mm	
SFSM01-02512SS	SFSM01-02512SS-BL	SFSM01-02512SS-NY		12mm	
SFSM01-02516SS	SFSM01-02516SS-BL	SFSM01-02516SS-NY		16mm	
SFSM01-02520SS	SFSM01-02520SS-BL	SFSM01-02520SS-NY	20mm		
SFSM01-02604SS	SFSM01-02604SS-BL	SFSM01-02604SS-NY	M2.6	4mm	100
SFSM01-02606SS	SFSM01-02606SS-BL	SFSM01-02606SS-NY		6mm	
SFSM01-02608SS	SFSM01-02608SS-BL	SFSM01-02608SS-NY		8mm	
SFSM01-02610SS	SFSM01-02610SS-BL	SFSM01-02610SS-NY		10mm	
SFSM01-02612SS	SFSM01-02612SS-BL	SFSM01-02612SS-NY		12mm	
SFSM01-02616SS	SFSM01-02616SS-BL	SFSM01-02616SS-NY		16mm	
SFSM01-02620SS	SFSM01-02620SS-BL	SFSM01-02620SS-NY	20mm		

**THREAD LOCKER**

- Reliable, Power Lock
- Multiple Reuse
- Minimizes Galling / Stripping
- Cost Saving

**THEFT RESISTANT SCREW (TRS)**

**SYSTEM MICRO EXTERNAL TYPE B MACHINE SCREW**



MEASUREMENT: METRIC  
 MATERIAL: STAINLESS STEEL A2  
 FINISH: PASSIVATED | BLACK | THREAD LOCK

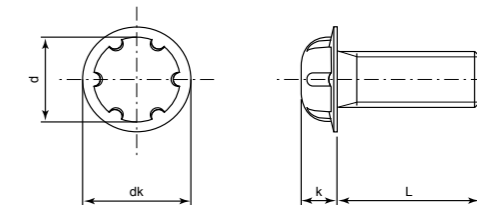

	M3	M4
dk	4.6	6.1
k	2.05	2.55
Drive Size	SM-3	SM-4
L	6-10mm	8-25mm

PART NUMBER			D	L	BOX QTY
SST (A2)	SS + BLACKEN	SST + THREAD LOCK			
SFSM02-0306SS	SFSM02-0306SS-BL	SFSM02-0306SS-NY	M3	6mm	50
SFSM02-0308SS	SFSM02-0308SS-BL	SFSM02-0308SS-NY		8mm	
SFSM02-0310SS	SFSM02-0310SS-BL	SFSM02-0310SS-NY		10mm	

SFSM02-0408SS	SFSM02-0408SS-BL	SFSM02-0408SS-NY	M4	8mm	50
SFSM02-0410SS	SFSM02-0410SS-BL	SFSM02-0410SS-NY		10mm	
SFSM02-0412SS	SFSM02-0412SS-BL	SFSM02-0412SS-NY		12mm	
SFSM02-0415SS	SFSM02-0415SS-BL	SFSM02-0415SS-NY		15mm	
SFSM02-0420SS	SFSM02-0420SS-BL	SFSM02-0420SS-NY		20mm	
SFSM02-0425SS	SFSM02-0425SS-BL	SFSM02-0425SS-NY		25mm	

**THREAD LOCKER**

- Reliable, Power Lock
- Multiple Reuse
- Minimizes Galling / Stripping
- Cost Saving

REFER TO PAGE 38 FOR TOOLS





**THEFT RESISTANT SCREW (TRS)**

**TRIO PIN BUTTON HEAD SCREW**

MEASUREMENT: METRIC  
 MATERIAL: STAINLESS STEEL A2  
 FINISH: PASSIVATED | BLACK | THREAD LOCK

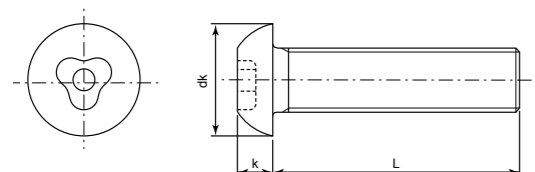

	M4	M5	M6	M8
dk	7.6	10.5	10.5	14
k	2.2	3.3	3.3	4.4
s	1	2		2.5
L	6-25mm	8-40mm	10-50mm	12-50mm

PART NUMBER			D	L	BOX QTY
SST (A2)	SS + BLACKEN	SST + THREAD LOCK			
SFTR01-0406SS	SFTR01-0406SS-BL	SFTR01-0406SS-NY	M4	6mm	100
SFTR01-0408SS	SFTR01-0408SS-BL	SFTR01-0408SS-NY		8mm	
SFTR01-0410SS	SFTR01-0410SS-BL	SFTR01-0410SS-NY		10mm	
SFTR01-0412SS	SFTR01-0412SS-BL	SFTR01-0412SS-NY		12mm	
SFTR01-0416SS	SFTR01-0416SS-BL	SFTR01-0416SS-NY		16mm	
SFTR01-0420SS	SFTR01-0420SS-BL	SFTR01-0420SS-NY		20mm	
SFTR01-0425SS	SFTR01-0425SS-BL	SFTR01-0425SS-NY		25mm	

SFTR01-0508SS	SFTR01-0508SS-BL	SFTR01-0508SS-NY	M5	8mm	100
SFTR01-0510SS	SFTR01-0510SS-BL	SFTR01-0510SS-NY		10mm	
SFTR01-0512SS	SFTR01-0512SS-BL	SFTR01-0512SS-NY		12mm	
SFTR01-0516SS	SFTR01-0516SS-BL	SFTR01-0516SS-NY		16mm	
SFTR01-0520SS	SFTR01-0520SS-BL	SFTR01-0520SS-NY		20mm	
SFTR01-0525SS	SFTR01-0525SS-BL	SFTR01-0525SS-NY		25mm	
SFTR01-0530SS	SFTR01-0530SS-BL	SFTR01-0530SS-NY		30mm	
SFTR01-0540SS	SFTR01-0540SS-BL	SFTR01-0540SS-NY		40mm	

PART NUMBER			D	L	BOX QTY
SST (A2)	SS + BLACKEN	SST + THREAD LOCK			
SFTR01-0610SS	SFTR01-0610SS-BL	SFTR01-0610SS-NY	M6	10mm	100
SFTR01-0612SS	SFTR01-0612SS-BL	SFTR01-0612SS-NY		12mm	
SFTR01-0616SS	SFTR01-0616SS-BL	SFTR01-0616SS-NY		16mm	
SFTR01-0620SS	SFTR01-0620SS-BL	SFTR01-0620SS-NY		20mm	
SFTR01-0625SS	SFTR01-0625SS-BL	SFTR01-0625SS-NY		25mm	
SFTR01-0630SS	SFTR01-0630SS-BL	SFTR01-0630SS-NY		30mm	
SFTR01-0640SS	SFTR01-0640SS-BL	SFTR01-0640SS-NY		40mm	
SFTR01-0650SS	SFTR01-0650SS-BL	SFTR01-0650SS-NY	50mm	50	

SFTR01-0812SS	SFTR01-0812SS-BL	SFTR01-0812SS-NY	M8	12mm	100
SFTR01-0816SS	SFTR01-0816SS-BL	SFTR01-0816SS-NY		16mm	
SFTR01-0820SS	SFTR01-0820SS-BL	SFTR01-0820SS-NY		20mm	
SFTR01-0825SS	SFTR01-0825SS-BL	SFTR01-0825SS-NY		25mm	
SFTR01-0830SS	SFTR01-0830SS-BL	SFTR01-0830SS-NY		30mm	
SFTR01-0840SS	SFTR01-0840SS-BL	SFTR01-0840SS-NY		40mm	
SFTR01-0850SS	SFTR01-0850SS-BL	SFTR01-0850SS-NY		50mm	

**THREAD LOCKER**

- Reliable, Power Lock
- Multiple Reuse
- Minimizes Galling / Stripping
- Cost Saving

REFER TO PAGE 38 FOR TOOLS







**THEFT RESISTANT SCREW (TRS)**

**TRI WING BUTTON HEAD SCREW**

MEASUREMENT: **METRIC**  
 MATERIAL: **STAINLESS STEEL A2**  
 FINISH: **PASSIVATED | BLACK | THREAD LOCK**

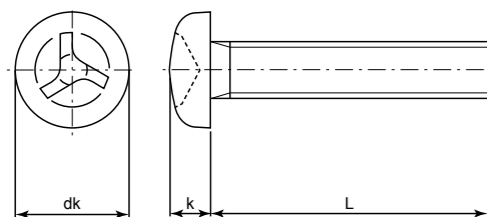

	M3	M4	M5	M6	M8
dk	5.7	8.2	9.5	12.5	15.7
k	1.8	2.92	3.37	4.45	5.55
s	W2	W4	W5	W6	W7
L	6-25mm	8-30mm	10-40mm	10-50mm	10-50mm

PART NUMBER			D	L	BOX QTY
SST (A2)	SS + BLACKEN	SST + <b>THREAD LOCK</b>			
SFTW01-0306SS	SFTW01-0306SS-BL	SFTW01-0306SS-NY	M3	6mm	100
SFTW01-0308SS	SFTW01-0308SS-BL	SFTW01-0308SS-NY		8mm	
SFTW01-0310SS	SFTW01-0310SS-BL	SFTW01-0310SS-NY		10mm	
SFTW01-0312SS	SFTW01-0312SS-BL	SFTW01-0312SS-NY		12mm	
SFTW01-0316SS	SFTW01-0316SS-BL	SFTW01-0316SS-NY		16mm	
SFTW01-0320SS	SFTW01-0320SS-BL	SFTW01-0320SS-NY		20mm	
SFTW01-0325SS	SFTW01-0325SS-BL	SFTW01-0325SS-NY		25mm	

SFTW01-0408SS	SFTW01-0408SS-BL	SFTW01-0408SS-NY	M4	8mm	100
SFTW01-0410SS	SFTW01-0410SS-BL	SFTW01-0410SS-NY		10mm	
SFTW01-0412SS	SFTW01-0412SS-BL	SFTW01-0412SS-NY		12mm	
SFTW01-0416SS	SFTW01-0416SS-BL	SFTW01-0416SS-NY		16mm	
SFTW01-0420SS	SFTW01-0420SS-BL	SFTW01-0420SS-NY		20mm	
SFTW01-0425SS	SFTW01-0425SS-BL	SFTW01-0425SS-NY		25mm	
SFTW01-0430SS	SFTW01-0430SS-BL	SFTW01-0430SS-NY		30mm	

SFTW01-0510SS	SFTW01-0510SS-BL	SFTW01-0510SS-NY	M5	10mm	100
SFTW01-0512SS	SFTW01-0512SS-BL	SFTW01-0512SS-NY		12mm	
SFTW01-0516SS	SFTW01-0516SS-BL	SFTW01-0516SS-NY		16mm	
SFTW01-0520SS	SFTW01-0520SS-BL	SFTW01-0520SS-NY		20mm	
SFTW01-0525SS	SFTW01-0525SS-BL	SFTW01-0525SS-NY		25mm	
SFTW01-0530SS	SFTW01-0530SS-BL	SFTW01-0530SS-NY		30mm	
SFTW01-0540SS	SFTW01-0540SS-BL	SFTW01-0540SS-NY		40mm	

PART NUMBER			D	L	BOX QTY
SST (A2)	SS + BLACKEN	SST + <b>THREAD LOCK</b>			
SFTW01-0610SS	SFTW01-0610SS-BL	SFTW01-0610SS-NY	M6	10mm	100
SFTW01-0612SS	SFTW01-0612SS-BL	SFTW01-0612SS-NY		12mm	
SFTW01-0616SS	SFTW01-0616SS-BL	SFTW01-0616SS-NY		16mm	
SFTW01-0620SS	SFTW01-0620SS-BL	SFTW01-0620SS-NY		20mm	
SFTW01-0625SS	SFTW01-0625SS-BL	SFTW01-0625SS-NY		25mm	
SFTW01-0630SS	SFTW01-0630SS-BL	SFTW01-0630SS-NY		30mm	
SFTW01-0640SS	SFTW01-0640SS-BL	SFTW01-0640SS-NY		40mm	
SFTW01-0650SS	SFTW01-0650SS-BL	SFTW01-0650SS-NY	50mm	50	

SFTW01-0810SS	SFTW01-0810SS-BL	SFTW01-0810SS-NY	M8	10mm	100
SFTW01-0812SS	SFTW01-0812SS-BL	SFTW01-0812SS-NY		12mm	
SFTW01-0816SS	SFTW01-0816SS-BL	SFTW01-0816SS-NY		16mm	
SFTW01-0820SS	SFTW01-0820SS-BL	SFTW01-0820SS-NY		20mm	
SFTW01-0825SS	SFTW01-0825SS-BL	SFTW01-0825SS-NY		25mm	
SFTW01-0830SS	SFTW01-0830SS-BL	SFTW01-0830SS-NY		30mm	
SFTW01-0840SS	SFTW01-0840SS-BL	SFTW01-0840SS-NY		40mm	
SFTW01-0850SS	SFTW01-0850SS-BL	SFTW01-0850SS-NY	50mm	50	

**THREAD LOCKER**

- Reliable, Power Lock
- Multiple Reuse
- Minimizes Galling / Stripping
- Cost Saving

REFER TO PAGE 38 FOR TOOLS



**THEFT RESISTANT SCREW (TRS)**



**TRI WING BUTTON HEAD SCREW**

MEASUREMENT: METRIC  
 MATERIAL: **STAINLESS STEEL A2**  
 FINISH: **PASSIVATED | BLACK | THREAD LOCK**

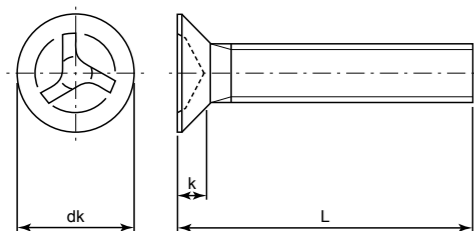

	M3	M4	M5	M6	M8
dk	5.5	8.4	9.3	11.3	15.8
k	1.65	2.7	2.7	3.3	4.65
s	W2	W4	W5	W6	W7
L	6-25mm	6-30mm	10-40mm	10-50mm	16-50mm

PART NUMBER			D	L	BOX QTY
SST (A2)	SS + BLACKEN	SST + <b>THREAD LOCK</b>			
SFTW02-0306SS	SFTW02-0306SS-BL	SFTW02-0306SS-NY	M3	6mm	100
SFTW02-0308SS	SFTW02-0308SS-BL	SFTW02-0308SS-NY		8mm	
SFTW02-0310SS	SFTW02-0310SS-BL	SFTW02-0310SS-NY		10mm	
SFTW02-0312SS	SFTW02-0312SS-BL	SFTW02-0312SS-NY		12mm	
SFTW02-0316SS	SFTW02-0316SS-BL	SFTW02-0316SS-NY		16mm	
SFTW02-0320SS	SFTW02-0320SS-BL	SFTW02-0320SS-NY		20mm	
SFTW02-0325SS	SFTW02-0325SS-BL	SFTW02-0325SS-NY		25mm	

SFTW02-0406SS	SFTW02-0406SS-BL	SFTW02-0406SS-NY	M4	6mm	100
SFTW02-0408SS	SFTW02-0408SS-BL	SFTW02-0408SS-NY		8mm	
SFTW02-0410SS	SFTW02-0410SS-BL	SFTW02-0410SS-NY		10mm	
SFTW02-0412SS	SFTW02-0412SS-BL	SFTW02-0412SS-NY		12mm	
SFTW02-0416SS	SFTW02-0416SS-BL	SFTW02-0416SS-NY		16mm	
SFTW02-0420SS	SFTW02-0420SS-BL	SFTW02-0420SS-NY		20mm	
SFTW02-0425SS	SFTW02-0425SS-BL	SFTW02-0425SS-NY		25mm	
SFTW02-0430SS	SFTW02-0430SS-BL	SFTW02-0430SS-NY		30mm	

SFTW02-0510SS	SFTW02-0510SS-BL	SFTW02-0510SS-NY	M5	10mm	100
SFTW02-0512SS	SFTW02-0512SS-BL	SFTW02-0512SS-NY		12mm	
SFTW02-0516SS	SFTW02-0516SS-BL	SFTW02-0516SS-NY		16mm	
SFTW02-0520SS	SFTW02-0520SS-BL	SFTW02-0520SS-NY		20mm	
SFTW02-0525SS	SFTW02-0525SS-BL	SFTW02-0525SS-NY		25mm	
SFTW02-0530SS	SFTW02-0530SS-BL	SFTW02-0530SS-NY		30mm	
SFTW02-0540SS	SFTW02-0540SS-BL	SFTW02-0540SS-NY	40mm		

PART NUMBER			D	L	BOX QTY
SST (A2)	SS + BLACKEN	SST + <b>THREAD LOCK</b>			
SFTW02-0610SS	SFTW02-0610SS-BL	SFTW02-0610SS-NY	M6	10mm	100
SFTW02-0612SS	SFTW02-0612SS-BL	SFTW02-0612SS-NY		12mm	
SFTW02-0616SS	SFTW02-0616SS-BL	SFTW02-0616SS-NY		16mm	
SFTW02-0620SS	SFTW02-0620SS-BL	SFTW02-0620SS-NY		20mm	
SFTW02-0625SS	SFTW02-0625SS-BL	SFTW02-0625SS-NY		25mm	
SFTW02-0630SS	SFTW02-0630SS-BL	SFTW02-0630SS-NY		30mm	
SFTW02-0640SS	SFTW02-0640SS-BL	SFTW02-0640SS-NY	40mm	50	
SFTW02-0650SS	SFTW02-0650SS-BL	SFTW02-0650SS-NY	50mm		

SFTW02-0816SS	SFTW02-0816SS-BL	SFTW02-0816SS-NY	M8	16mm	100
SFTW02-0820SS	SFTW02-0820SS-BL	SFTW02-0820SS-NY		20mm	
SFTW02-0825SS	SFTW02-0825SS-BL	SFTW02-0825SS-NY		25mm	
SFTW02-0830SS	SFTW02-0830SS-BL	SFTW02-0830SS-NY		30mm	
SFTW02-0840SS	SFTW02-0840SS-BL	SFTW02-0840SS-NY		40mm	
SFTW02-0850SS	SFTW02-0850SS-BL	SFTW02-0850SS-NY		50mm	

**THREAD LOCKER**

- Reliable, Power Lock
- Multiple Reuse
- Minimizes Galling / Stripping
- Cost Saving

REFER TO PAGE 38 FOR TOOLS



**THEFT RESISTANT SCREW (TRS)**

**THEFT RESISTANT SCREW (TRS)**

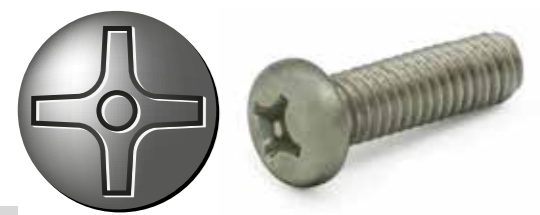

**PHILIP PIN PAN HEAD MACHINE SCREW**

**BREAKAWAY TAMPER NUT | NON-REMOVABLE**



MEASUREMENT: **METRIC**  
 MATERIAL: **STAINLESS STEEL A2**  
 FINISH: **PASSIVATED | BLACK | THREAD LOCK**

MEASUREMENT: **METRIC**  
 MATERIAL: **STAINLESS STEEL A2**  
 FINISH: **PASSIVATED**

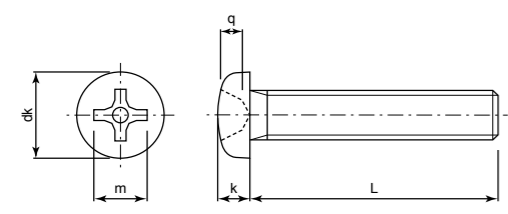

	M3	M4	M5	M6
dk	5.5	7	9	10.5
k	2	2.6	3.3	3.9
L	6-10mm	6-16mm	10-20mm	10-20mm
Drive Size		#2		#3

	M6	M8	M10	M12	M16
m	3.5	4	5	5.5	7
sw	10	13	17	19	24

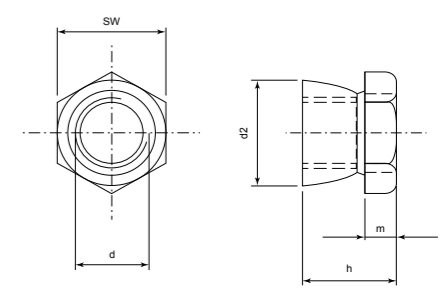

PART NUMBER			D	L	BOX QTY
SST (A2)	SS + BLACKEN	SST + <b>THREAD LOCK</b>			
SFPP01-0306SS	SFPP01-0306SS-BL	SFPP01-0306SS-NY	M3	6mm	100
SFPP01-0308SS	SFPP01-0308SS-BL	SFPP01-0308SS-NY		8mm	
SFPP01-0310SS	SFPP01-0310SS-BL	SFPP01-0310SS-NY		10mm	
SFPP01-0406SS	SFPP01-0406SS-BL	SFPP01-0406SS-NY	M4	6mm	100
SFPP01-0410SS	SFPP01-0410SS-BL	SFPP01-0410SS-NY		10mm	
SFPP01-0416SS	SFPP01-0416SS-BL	SFPP01-0416SS-NY		16mm	
SFPP01-0510SS	SFPP01-0510SS-BL	SFPP01-0510SS-NY	M5	10mm	100
SFPP01-0516SS	SFPP01-0516SS-BL	SFPP01-0516SS-NY		16mm	
SFPP01-0520SS	SFPP01-0520SS-BL	SFPP01-0520SS-NY		20mm	
SFPP01-0610SS	SFPP01-0610SS-BL	SFPP01-0610SS-NY	M6	10mm	100
SFPP01-0616SS	SFPP01-0616SS-BL	SFPP01-0616SS-NY		16mm	
SFPP01-0620SS	SFPP01-0620SS-BL	SFPP01-0620SS-NY		20mm	

PART NUMBER		D	BOX QTY
SST (A2)			
SFTN01-06SS	M6	10	
SFTN01-08SS	M8	10	
SFTN01-10SS	M10	10	
SFTN01-12SS	M12	10	
SFTN01-16SS	M16	10	

**THREAD LOCKER**

- Reliable, Power Lock
- Multiple Reuse
- Minimizes Galling / Stripping
- Cost Saving

REFER TO PAGE 38 FOR TOOLS





## TOOLS - BITS & KEYS - METRIC



**HP BIT FOR TRS**  
[SOCKET PIN USE]

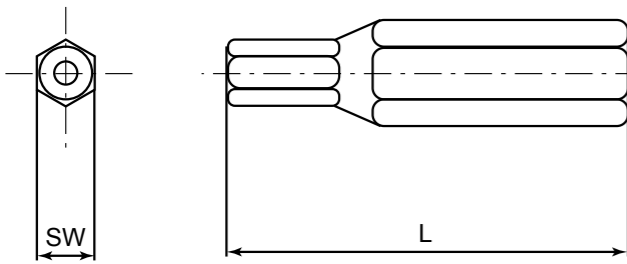

SIZE	PART NUMBER	QTY	SHANK FIT
2	SFHP02B	1	6.35
2.5	SFHP025B		6.35
3	SFHP03B		6.35
4	SFHP04B		6.35
5	SFHP05B		6.35
6	SFHP06B		6.35
8	SFHP08B		8
1/8"	SFHP018B		6.35
5/32"	SFHP0532B		6.35



**TP BIT FOR TRS**  
[TORX PIN USE]

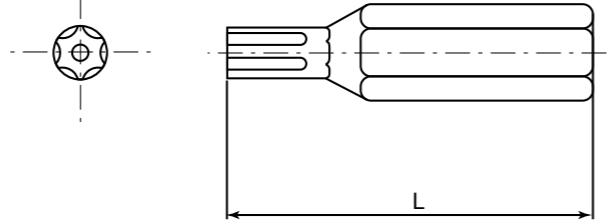

SIZE	PART NUMBER	QTY	SHANK FIT
T6	SFTP06B	1	6.35
T8	SFTP08B		
T10	SFTP10B		
T15	SFTP15B		
T20	SFTP20B		
T25	SFTP25B		
T27	SFTP27B		
T30	SFTP30B		
T40	SFTP40B		
T45	SFTP45B		

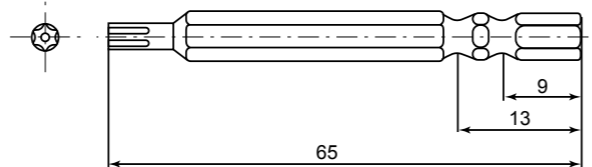

SIZE	PART NUMBER	QTY	SHANK FIT
T20	SFTP20B-XL	1	6.35



**TR BIT FOR TRS**  
[TRIO PIN USE]

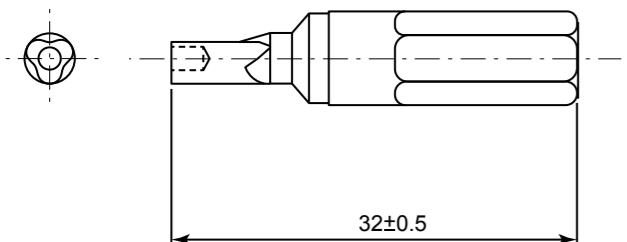

SIZE	PART NUMBER	QTY	SHANK FIT
#1	SFTR01B	1	6.35
#2	SFTR02B		
#2.5	SFTR025B		



**SM BIT FOR TRS**  
[SYSTEM MICRO USE]

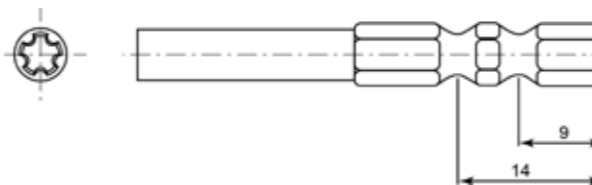

SIZE	PART NUMBER	QTY	SHANK FIT
M2 & M2.3	SFSM01B	1	6.35
M2.5 & M2.6	SFSM02B		
M3	SFSM03B		
M4	SFSM04B		

## TOOLS - BITS & KEYS - METRIC



**DS BIT FOR TRS**  
[DRILL SPANNER USE]

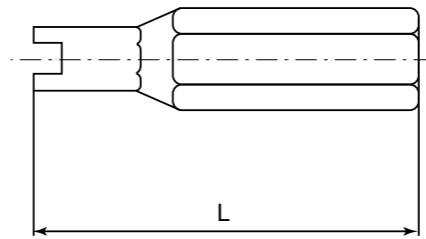

SIZE	PART NUMBER	QTY	SHANK FIT
4	SFDS04B	1	6.35
6	SFDS06B		
8	SFDS08B		
10	SFDS10B		
12	SFDS12B		
14	SFDS14B		



**DS BIT FOR TRS**  
[DRILL SPANNER USE ON NUT]

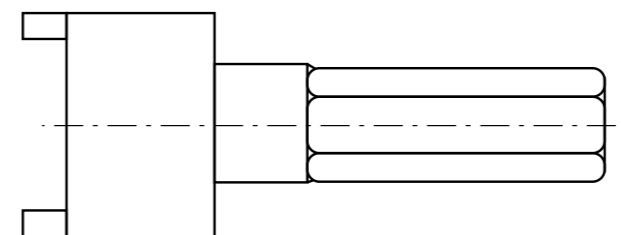

SIZE	PART NUMBER	QTY	SHANK FIT
-	SFDSN01B	1	6.35



**PP BIT FOR TRS**  
[PHILIP PIN USE]

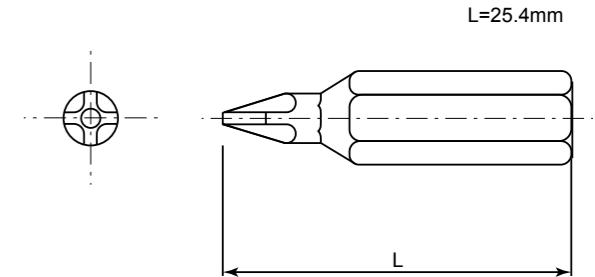

SIZE	PART NUMBER	QTY	SHANK FIT
#2	SFPP02B	1	6.35
#3	SFPP03B		



**TW BIT FOR TRS**  
[TRIO WING USE]

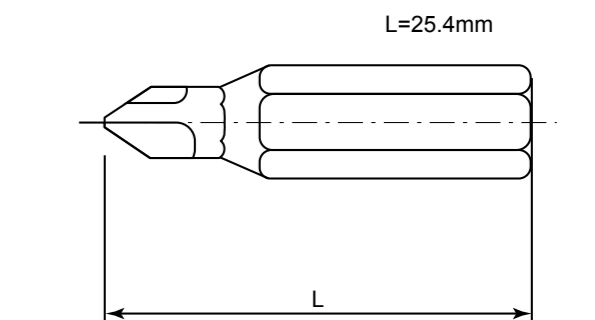

SIZE	PART NUMBER	QTY	SHANK FIT
W2	SFTW02B	1	6.35
W3	SFTW03B		
W4	SFTW04B		
W5	SFTW05B		
W6	SFTW06B		
W7	SFTW07B		

HP



TP



DS



OW



SM



TR



TW



PP



TN



HP



TP



DS



OW



SM



TR



TW



PP



TN



BACK

## TOOLS - BITS & KEYS - METRIC



### HP KEYS FOR TRS [SOCKET PIN USE]

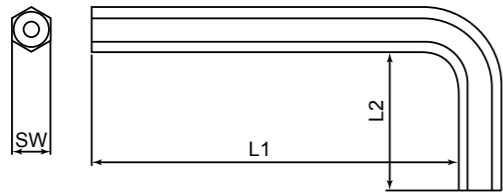

SIZE	PART NUMBER	QTY	REFERENCE
2	SFHP02L	1	M3
2.5	SFHP025L		M4
3	SFHP03L		M5
4	SFHP04L		M6
5	SFHP05L		M8
6	SFHP06L		M10
8	SFHP08L		M12
1/8"	SFHP018L		3.5, #6
5/32"	SFHP0532L		4.2, 4.8, #8, #10



### TP KEYS FOR TRS [TORX PIN USE]

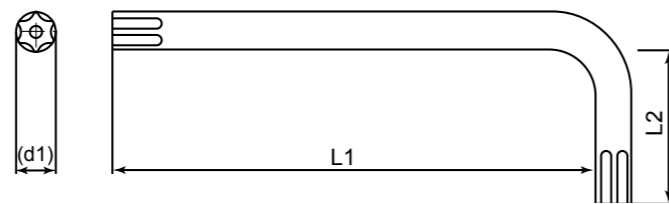

SIZE	PART NUMBER	QTY	REFERENCE
T6	SFTP06L	1	M2
T8	SFTP08L		M2.6
T10	SFTP10L		M3
T15	SFTP15L		-
T20	SFTP20L		M4
T25	SFTP25L		M5
T27	SFTP27L		-
T30	SFTP30L		M6
T40	SFTP40L		M8
T45	SFTP45L		M10



### ONE WAY REMOVAL TOOL [FOR REMOVING USE ONLY]

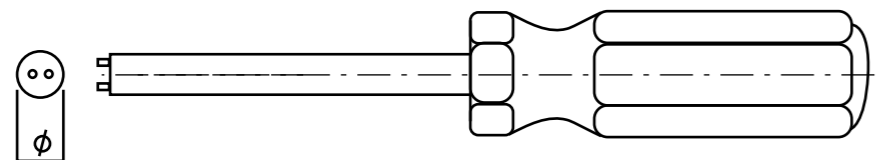

SIZE	PART NUMBER	QTY	REFERENCE
400	SFOW400TL	1	M3   M4   3.5   4.2
500	SFOW500TL		M5   4.2   4.8
600	SFOW600TL		M6

## TOOLS - BITS & KEYS - METRIC

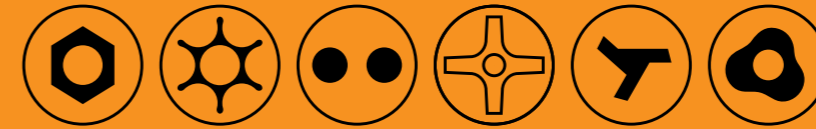

### FAST DRIVER HOLDER [FITS ALL BITS]

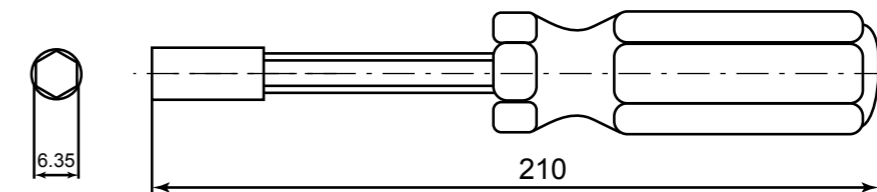
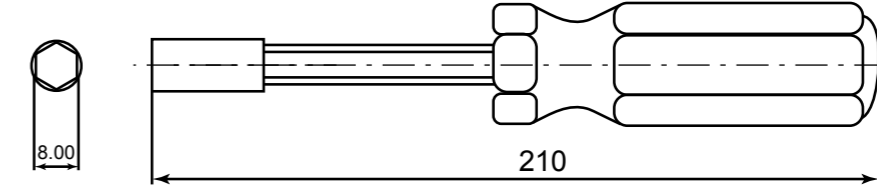

SIZE	PART NUMBER	QTY	SHANK FIT
1/4" (M6)	SFHDR01	1	6.35
5/16" (M8)	SFHDR02		8



### DS DRIVER FOR TRS [DRILL SPANNER USE ON NUT]

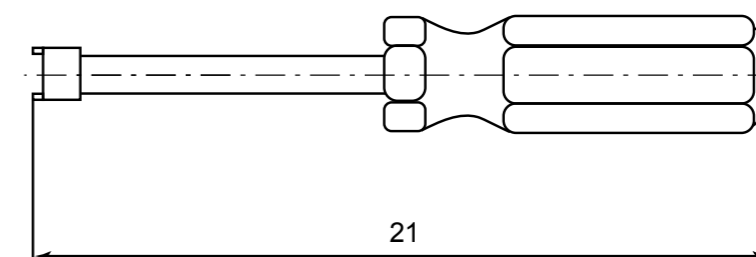

SIZE	PART NUMBER	QTY	REMARKS
-	SFDSN01DR	1	M6, 8, 10







**SYNERGIX**<sup>®</sup>  
SECURITY SCREWS



**SYNERGIX**<sup>®</sup>  
SECURITY SCREWS

**TAMPER  
RESISTANCE  
FASTENERS**

**INCH SERIES**





**THEFT RESISTANT SCREW (TRS)**

**HEXAGON BUTTON WITH PIN**

MEASUREMENT: INCH  
 MATERIAL: **STAINLESS STEEL 18-8**  
 FINISH: **PASSIVATED | BLACK | THREAD LOCK**

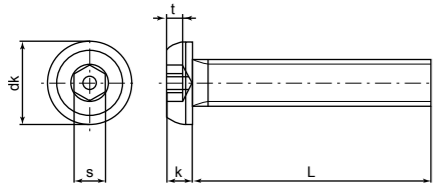

	4-40	6-32	8-32	10-24	10-32	1/4-20	5/16-18	3/8-16
dk (REF)	0.213	0.262	0.312	0.361	0.361	0.437	0.547	0.656
k (REF)	0.059	0.063	0.087	0.101	0.101	0.132	0.166	0.199
TOOL SIZE*	3/32	1/8"	1/8"	5/32"	5/32"	5/32"	3/16"	7/32"

\*ABOVE DIMENSIONS ARE FOR HEX OR TORX PIN, WITH EXCEPTION TO THE TOOL SIZE

PART NUMBER			D	L	BOX QTY
SST (18-8)	SS + BLACKEN	SST + <b>THREAD LOCK</b>			
SFHP01-#4.025SS	SFHP01-#4.025SS-BK	SFHP01-#4.025SS-NY	4-40	1/4"	50
SFHP01-#4.037SS	SFHP01-#4.037SS-BK	SFHP01-#4.037SS-NY		3/8"	
SFHP01-#4.050SS	SFHP01-#4.050SS-BK	SFHP01-#4.050SS-NY		1/2"	
SFHP01-#4.075SS	SFHP01-#4.075SS-BK	SFHP01-#4.075SS-NY		3/4"	
SFHP01-#4.100SS	SFHP01-#4.100SS-BK	SFHP01-#4.100SS-NY		1"	
SFHP01-#6.025SS	SFHP01-#6.025SS-BK	SFHP01-#6.025SS-NY	6-32	1/4"	50
SFHP01-#6.031SS	SFHP01-#6.031SS-BK	SFHP01-#6.031SS-NY		5/16"	
SFHP01-#6.037SS	SFHP01-#6.037SS-BK	SFHP01-#6.037SS-NY		3/8"	
SFHP01-#6.050SS	SFHP01-#6.050SS-BK	SFHP01-#6.050SS-NY		1/2"	
SFHP01-#6.062SS	SFHP01-#6.062SS-BK	SFHP01-#6.062SS-NY		5/8"	
SFHP01-#6.075SS	SFHP01-#6.075SS-BK	SFHP01-#6.075SS-NY		3/4"	
SFHP01-#6.100SS	SFHP01-#6.100SS-BK	SFHP01-#6.100SS-NY		1"	
SFHP01-#6.125SS	SFHP01-#6.125SS-BK	SFHP01-#6.125SS-NY		1-1/4"	
SFHP01-#6.150SS	SFHP01-#6.150SS-BK	SFHP01-#6.150SS-NY		1-1/2"	
SFHP01-#8.025SS	SFHP01-#8.025SS-BK	SFHP01-#8.025SS-NY	8-32	1/4"	50
SFHP01-#8.037SS	SFHP01-#8.037SS-BK	SFHP01-#8.037SS-NY		3/8"	
SFHP01-#8.050SS	SFHP01-#8.050SS-BK	SFHP01-#8.050SS-NY		1/2"	
SFHP01-#8.062SS	SFHP01-#8.062SS-BK	SFHP01-#8.062SS-NY		5/8"	
SFHP01-#8.075SS	SFHP01-#8.075SS-BK	SFHP01-#8.075SS-NY		3/4"	
SFHP01-#8.100SS	SFHP01-#8.100SS-BK	SFHP01-#8.100SS-NY		1"	
SFHP01-#8.125SS	SFHP01-#8.125SS-BK	SFHP01-#8.125SS-NY		1-1/4"	
SFHP01-#8.150SS	SFHP01-#8.150SS-BK	SFHP01-#8.150SS-NY		1-1/2"	
SFHP01-#8.200SS	SFHP01-#8.200SS-BK	SFHP01-#8.200SS-NY		2"	
SFHP01-#10C.025SS	SFHP01-#10C.025SS-BK	SFHP01-#10C.025SS-NY	10-24	1/4"	25
SFHP01-#10C.037SS	SFHP01-#10C.037SS-BK	SFHP01-#10C.037SS-NY		3/8"	
SFHP01-#10C.050SS	SFHP01-#10C.050SS-BK	SFHP01-#10C.050SS-NY		1/2"	
SFHP01-#10C.062SS	SFHP01-#10C.062SS-BK	SFHP01-#10C.062SS-NY		5/8"	
SFHP01-#10C.075SS	SFHP01-#10C.075SS-BK	SFHP01-#10C.075SS-NY		3/4"	
SFHP01-#10C.100SS	SFHP01-#10C.100SS-BK	SFHP01-#10C.100SS-NY		1"	
SFHP01-#10C.125SS	SFHP01-#10C.125SS-BK	SFHP01-#10C.125SS-NY		1-1/4"	
SFHP01-#10C.150SS	SFHP01-#10C.150SS-BK	SFHP01-#10C.150SS-NY		1-1/2"	

PART NUMBER			D	L	BOX QTY		
SST (18-8)	SS + BLACKEN	SST + <b>THREAD LOCK</b>					
SFHP01-#10F.025SS	SFHP01-#10F.025SS-BK	SFHP01-#10F.025SS-NY	10-32	1/4"	25		
SFHP01-#10F.031SS	SFHP01-#10F.031SS-BK	SFHP01-#10F.031SS-NY		5/16"			
SFHP01-#10F.037SS	SFHP01-#10F.037SS-BK	SFHP01-#10F.037SS-NY		3/8"			
SFHP01-#10F.043SS	SFHP01-#10F.043SS-BK	SFHP01-#10F.043SS-NY		7/16"			
SFHP01-#10F.050SS	SFHP01-#10F.050SS-BK	SFHP01-#10F.050SS-NY		1/2"			
SFHP01-#10F.062SS	SFHP01-#10F.062SS-BK	SFHP01-#10F.062SS-NY		5/8"			
SFHP01-#10F.075SS	SFHP01-#10F.075SS-BK	SFHP01-#10F.075SS-NY		3/4"			
SFHP01-#10F.100SS	SFHP01-#10F.100SS-BK	SFHP01-#10F.100SS-NY		1"			
SFHP01-#10F.125SS	SFHP01-#10F.125SS-BK	SFHP01-#10F.125SS-NY		1-1/4"			
SFHP01-#10F.150SS	SFHP01-#10F.150SS-BK	SFHP01-#10F.150SS-NY		1-1/2"			
SFHP01-#10F.200SS	SFHP01-#10F.200SS-BK	SFHP01-#10F.200SS-NY		2"			
SFHP01-025.025SS	SFHP01-025.025SS-BK	SFHP01-025.025SS-NY		1/4-20		1/4"	25
SFHP01-025.031SS	SFHP01-025.031SS-BK	SFHP01-025.031SS-NY				5/16"	
SFHP01-025.037SS	SFHP01-025.037SS-BK	SFHP01-025.037SS-NY				3/8"	
SFHP01-025.050SS	SFHP01-025.050SS-BK	SFHP01-025.050SS-NY				1/2"	
SFHP01-025.062SS	SFHP01-025.062SS-BK	SFHP01-025.062SS-NY	5/8"				
SFHP01-025.075SS	SFHP01-025.075SS-BK	SFHP01-025.075SS-NY	3/4"				
SFHP01-025.100SS	SFHP01-025.100SS-BK	SFHP01-025.100SS-NY	1"				
SFHP01-025.125SS	SFHP01-025.125SS-BK	SFHP01-025.125SS-NY	1-1/4"				
SFHP01-025.150SS	SFHP01-025.150SS-BK	SFHP01-025.150SS-NY	1-1/2"				
SFHP01-025.200SS	SFHP01-025.200SS-BK	SFHP01-025.200SS-NY	2"				
SFHP01-025.225SS	SFHP01-025.225SS-BK	SFHP01-025.225SS-NY	2-1/4"				
SFHP01-025.250SS	SFHP01-025.250SS-BK	SFHP01-025.250SS-NY	2-1/2"				
SFHP01-031.050SS	SFHP01-031.050SS-BK	SFHP01-031.050SS-NY	5/16-18	1/2"	25		
SFHP01-031.062SS	SFHP01-031.062SS-BK	SFHP01-031.062SS-NY		5/8"			
SFHP01-031.075SS	SFHP01-031.075SS-BK	SFHP01-031.075SS-NY		3/4"			
SFHP01-031.100SS	SFHP01-031.100SS-BK	SFHP01-031.100SS-NY		1"			
SFHP01-031.125SS	SFHP01-031.125SS-BK	SFHP01-031.125SS-NY		1-1/4"			
SFHP01-031.150SS	SFHP01-031.150SS-BK	SFHP01-031.150SS-NY		1-1/2"			
SFHP01-031.200SS	SFHP01-031.200SS-BK	SFHP01-031.200SS-NY		2"			
SFHP01-037.050SS	SFHP01-037.050SS-BK	SFHP01-037.050SS-NY	3/8-16	1/2"	25		
SFHP01-037.062SS	SFHP01-037.062SS-BK	SFHP01-037.062SS-NY		5/8"			
SFHP01-037.075SS	SFHP01-037.075SS-BK	SFHP01-037.075SS-NY		3/4"			
SFHP01-037.100SS	SFHP01-037.100SS-BK	SFHP01-037.100SS-NY		1"			
SFHP01-037.125SS	SFHP01-037.125SS-BK	SFHP01-037.125SS-NY		1-1/4"			
SFHP01-037.150SS	SFHP01-037.150SS-BK	SFHP01-037.150SS-NY		1-1/2"			
SFHP01-037.200SS	SFHP01-037.200SS-BK	SFHP01-037.200SS-NY		2"			
SFHP01-037.225SS	SFHP01-037.225SS-BK	SFHP01-037.225SS-NY		2-1/4"			
SFHP01-037.250SS	SFHP01-037.250SS-BK	SFHP01-037.250SS-NY		2-1/2"			

**THREAD LOCKER**

- Reliable, Power Lock
- Multiple Reuse
- Minimizes Galling / Stripping
- Cost Saving

REFER TO 62 PAGES FOR TOOLS





**THEFT RESISTANT SCREW (TRS)**

**HEXAGON FLAT WITH PIN**

MEASUREMENT: INCH  
 MATERIAL: **STAINLESS STEEL 18-8**  
 FINISH: **PASSIVATED | BLACK | THREAD LOCK**



	4-40	6-32	8-32	10-24	10-32	1/4-20	5/16-18	3/8-16
dk (REF)	0.255	0.307	0.359	0.411	0.411	0.531	0.656	0.781
k (REF)	0.083	0.097	0.112	0.127	0.127	0.161	0.198	0.234
TOOL SIZE*	3/32	1/8	5/32	5/32	5/32	5/32	3/16	3/16

\*ABOVE DIMENSIONS ARE FOR HEX OR TORX PIN, WITH EXCEPTION TO THE TOOL SIZE

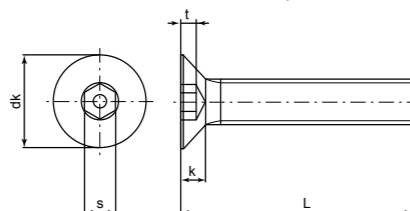

PART NUMBER			D	L	BOX QTY
SST (18-8)	SS + BLACKEN	SST + <b>THREAD LOCK</b>			
SFHP02-#4.037SS	SFHP02-#4.037SS-BK	SFHP02-#4.037SS-NY	4-40	3/8"	50
SFHP02-#4.050SS	SFHP02-#4.050SS-BK	SFHP02-#4.050SS-NY		1/2"	
SFHP02-#4.075SS	SFHP02-#4.075SS-BK	SFHP02-#4.075SS-NY		3/4"	
SFHP02-#4.100SS	SFHP02-#4.100SS-BK	SFHP02-#4.100SS-NY		1"	
SFHP02-#6.025SS	SFHP02-#6.025SS-BK	SFHP02-#6.025SS-NY		6-32	
SFHP02-#6.037SS	SFHP02-#6.037SS-BK	SFHP02-#6.037SS-NY	3/8"		
SFHP02-#6.050SS	SFHP02-#6.050SS-BK	SFHP02-#6.050SS-NY	1/2"		
SFHP02-#6.062SS	SFHP02-#6.062SS-BK	SFHP02-#6.062SS-NY	5/8"		
SFHP02-#6.075SS	SFHP02-#6.075SS-BK	SFHP02-#6.075SS-NY	3/4"		
SFHP02-#6.100SS	SFHP02-#6.100SS-BK	SFHP02-#6.100SS-NY	1"		
SFHP02-#6.125SS	SFHP02-#6.125SS-BK	SFHP02-#6.125SS-NY	1-1/4"		
SFHP02-#6.150SS	SFHP02-#6.150SS-BK	SFHP02-#6.150SS-NY	1-1/2"		
SFHP02-#6.200SS	SFHP02-#6.200SS-BK	SFHP02-#6.200SS-NY	2"		
SFHP02-#8.025SS	SFHP02-#8.025SS-BK	SFHP02-#8.025SS-NY	8-32		1/4"
SFHP02-#8.037SS	SFHP02-#8.037SS-BK	SFHP02-#8.037SS-NY		3/8"	
SFHP02-#8.050SS	SFHP02-#8.050SS-BK	SFHP02-#8.050SS-NY		1/2"	
SFHP02-#8.062SS	SFHP02-#8.062SS-BK	SFHP02-#8.062SS-NY		5/8"	
SFHP02-#8.075SS	SFHP02-#8.075SS-BK	SFHP02-#8.075SS-NY		3/4"	
SFHP02-#8.100SS	SFHP02-#8.100SS-BK	SFHP02-#8.100SS-NY		1"	
SFHP02-#8.125SS	SFHP02-#8.125SS-BK	SFHP02-#8.125SS-NY		1-1/4"	
SFHP02-#8.150SS	SFHP02-#8.150SS-BK	SFHP02-#8.150SS-NY		1-1/2"	
SFHP02-#8.200SS	SFHP02-#8.200SS-BK	SFHP02-#8.200SS-NY		2"	

PART NUMBER			D	L	BOX QTY
SST (18-8)	SS + BLACKEN	SST + <b>THREAD LOCK</b>			
SFHP02-#10C.025SS	SFHP02-#10C.025SS-BK	SFHP02-#10C.025SS-NY	10-24	1/4"	25
SFHP02-#10C.037SS	SFHP02-#10C.037SS-BK	SFHP02-#10C.037SS-NY		3/8"	
SFHP02-#10C.050SS	SFHP02-#10C.050SS-BK	SFHP02-#10C.050SS-NY		1/2"	
SFHP02-#10C.062SS	SFHP02-#10C.062SS-BK	SFHP02-#10C.062SS-NY		5/8"	
SFHP02-#10C.075SS	SFHP02-#10C.075SS-BK	SFHP02-#10C.075SS-NY		3/4"	
SFHP02-#10C.100SS	SFHP02-#10C.100SS-BK	SFHP02-#10C.100SS-NY		1"	
SFHP02-#10C.125SS	SFHP02-#10C.125SS-BK	SFHP02-#10C.125SS-NY		1-1/4"	
SFHP02-#10C.150SS	SFHP02-#10C.150SS-BK	SFHP02-#10C.150SS-NY		1-1/2"	
SFHP02-#10C.200SS	SFHP02-#10C.200SS-BK	SFHP02-#10C.200SS-NY		2"	
SFHP02-#10F.025SS	SFHP02-#10F.025SS-BK	SFHP02-#10F.025SS-NY		10-32	
SFHP02-#10F.037SS	SFHP02-#10F.037SS-BK	SFHP02-#10F.037SS-NY	3/8"		
SFHP02-#10F.050SS	SFHP02-#10F.050SS-BK	SFHP02-#10F.050SS-NY	1/2"		
SFHP02-#10F.062SS	SFHP02-#10F.062SS-BK	SFHP02-#10F.062SS-NY	5/8"		
SFHP02-#10F.075SS	SFHP02-#10F.075SS-BK	SFHP02-#10F.075SS-NY	3/4"		
SFHP02-#10F.100SS	SFHP02-#10F.100SS-BK	SFHP02-#10F.100SS-NY	1"		
SFHP02-#10F.125SS	SFHP02-#10F.125SS-BK	SFHP02-#10F.125SS-NY	1-1/4"		
SFHP02-#10F.150SS	SFHP02-#10F.150SS-BK	SFHP02-#10F.150SS-NY	1-1/2"		
SFHP02-#10F.200SS	SFHP02-#10F.200SS-BK	SFHP02-#10F.200SS-NY	2"		
SFHP02-025.037SS	SFHP02-025.037SS-BK	SFHP02-025.037SS-NY	1/4-20		3/8"
SFHP02-025.050SS	SFHP02-025.050SS-BK	SFHP02-025.050SS-NY		1/2"	
SFHP02-025.062SS	SFHP02-025.062SS-BK	SFHP02-025.062SS-NY		5/8"	
SFHP02-025.075SS	SFHP02-025.075SS-BK	SFHP02-025.075SS-NY		3/4"	
SFHP02-025.100SS	SFHP02-025.100SS-BK	SFHP02-025.100SS-NY		1"	
SFHP02-025.125SS	SFHP02-025.125SS-BK	SFHP02-025.125SS-NY		1-1/4"	
SFHP02-025.150SS	SFHP02-025.150SS-BK	SFHP02-025.150SS-NY		1-1/2"	
SFHP02-025.200SS	SFHP02-025.200SS-BK	SFHP02-025.200SS-NY		2"	
SFHP02-031.050SS	SFHP02-031.050SS-BK	SFHP02-031.050SS-NY	5/16-18	1/2"	25
SFHP02-031.062SS	SFHP02-031.062SS-BK	SFHP02-031.062SS-NY		5/8"	
SFHP02-031.075SS	SFHP02-031.075SS-BK	SFHP02-031.075SS-NY		3/4"	
SFHP02-031.100SS	SFHP02-031.100SS-BK	SFHP02-031.100SS-NY		1"	
SFHP02-031.125SS	SFHP02-031.125SS-BK	SFHP02-031.125SS-NY		1-1/4"	
SFHP02-031.150SS	SFHP02-031.150SS-BK	SFHP02-031.150SS-NY		1-1/2"	
SFHP02-031.200SS	SFHP02-031.200SS-BK	SFHP02-031.200SS-NY		2"	
SFHP02-037.062SS	SFHP02-037.062SS-BK	SFHP02-037.062SS-NY		3/8-16	
SFHP02-037.075SS	SFHP02-037.075SS-BK	SFHP02-037.075SS-NY	3/4"		
SFHP02-037.100SS	SFHP02-037.100SS-BK	SFHP02-037.100SS-NY	1"		
SFHP02-037.125SS	SFHP02-037.125SS-BK	SFHP02-037.125SS-NY	1-1/4"		
SFHP02-037.150SS	SFHP02-037.150SS-BK	SFHP02-037.150SS-NY	1-1/2"		
SFHP02-037.200SS	SFHP02-037.200SS-BK	SFHP02-037.200SS-NY	2"		

**THREAD LOCKER**

- Reliable, Power Lock
- Multiple Reuse
- Minimizes Galling / Stripping
- Cost Saving

REFER TO 62 PAGES FOR TOOLS



**THEFT RESISTANT SCREW (TRS)**



**HEX PIN BUTTON HEAD SHEET METAL SCREW  
TYPE AB**

MEASUREMENT: INCH  
MATERIAL: **STAINLESS STEEL 18-8**  
FINISH: **PASSIVATED | BLACK**

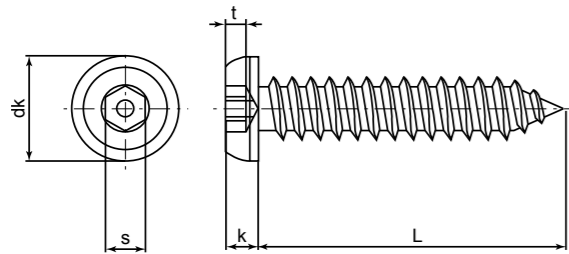

	3.5 (#6)	4.2 (#8)	4.8 (#10)	6.3 (1/4)
dk	0.22	0.30	0.37	0.41
k	0.06	0.09	0.11	0.13
s	SW 2	SW 2.5	SW 3	SW 4

**THEFT RESISTANT SCREW (TRS)**

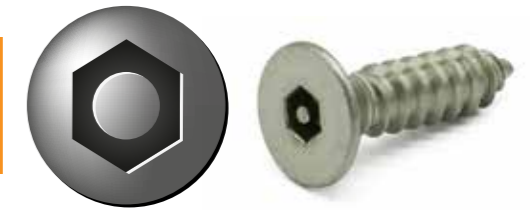

**HEX PIN FLAT HEAD SHEET METAL SCREW  
TYPE AB**

MEASUREMENT: INCH  
MATERIAL: **STAINLESS STEEL 18-8**  
FINISH: **PASSIVATED | BLACK**

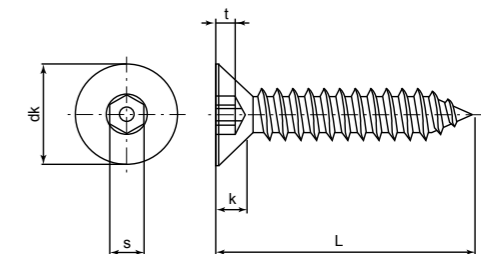

	3.5 (#6)	4.2 (#8)	4.8 (#10)	5.5 (#12)	6.3 (1/4)
dk	0.27	0.32	0.37	0.43	0.49
k	0.08	0.10	0.12	0.14	0.16
s	SW 2	SW 2.5	SW 3	SW 4	SW 4

PART NUMBER		D	L	BOX QTY	PART NUMBER		D	L	BOX QTY
SST (18-8)	SS + BLACKEN				SST (18-8)	SS + BLACKEN			
SFHP03#6.10SS	SFHP03#6.10SS-BL	#6	3/8"	50	SFHP03#10.13SS	SFHP03#10.13SS-BL	#10	1/2"	50
SFHP03#6.13SS	SFHP03#6.13SS-BL		1/2"		SFHP03#10.16SS	SFHP03#10.16SS-BL		5/8"	
SFHP03#6.16SS	SFHP03#6.16SS-BL		5/8"		SFHP03#10.19SS	SFHP03#10.19SS-BL		3/4"	
SFHP03#6.19SS	SFHP03#6.19SS-BL		3/4"		SFHP03#10.25SS	SFHP03#10.25SS-BL		1"	
SFHP03#6.25SS	SFHP03#6.25SS-BL		1"		SFHP03#10.32SS	SFHP03#10.32SS-BL		1-1/4"	
SFHP03#6.32SS	SFHP03#6.32SS-BL		1-1/4"		SFHP03#10.38SS	SFHP03#10.38SS-BL		1-1/2"	
SFHP03#6.38SS	SFHP03#6.38SS-BL		1-1/2"		SFHP03#10.50SS	SFHP03#10.50SS-BL		2"	
SFHP03#6.50SS	SFHP03#6.50SS-BL		2"		SFHP03025.13SS	SFHP03025.13SS-BL		1/2"	
SFHP03#8.10SS	SFHP03#8.10SS-BL	#8	3/8"	50	SFHP03025.16SS	SFHP03025.16SS-BL	1/4	5/8"	50
SFHP03#8.13SS	SFHP03#8.13SS-BL		1/2"		SFHP03025.19SS	SFHP03025.19SS-BL		3/4"	
SFHP03#8.16SS	SFHP03#8.16SS-BL		5/8"		SFHP03025.25SS	SFHP03025.25SS-BL		1"	
SFHP03#8.19SS	SFHP03#8.19SS-BL		3/4"		SFHP03025.32SS	SFHP03025.32SS-BL		1-1/4"	
SFHP03#8.25SS	SFHP03#8.25SS-BL		1"		SFHP03025.38SS	SFHP03025.38SS-BL		1-1/2"	
SFHP03#8.32SS	SFHP03#8.32SS-BL		1-1/4"		SFHP03025.50SS	SFHP03025.50SS-BL		2"	
SFHP03#8.38SS	SFHP03#8.38SS-BL		1-1/2"						
SFHP03#8.50SS	SFHP03#8.50SS-BL		2"						

PART NUMBER		D	L	BOX QTY	PART NUMBER		D	L	BOX QTY
SST (18-8)	SS + BLACKEN				SST (18-8)	SS + BLACKEN			
SFHP04-#6.10SS	SFHP04-#6.10SS-BL	#6	3/8"	50	SFHP04-#12.13SS	SFHP04-#12.13SS-BL	#12	1/2"	50
SFHP04-#6.13SS	SFHP04-#6.13SS-BL		1/2"		SFHP04-#12.16SS	SFHP04-#12.16SS-BL		5/8"	
SFHP04-#6.16SS	SFHP04-#6.16SS-BL		5/8"		SFHP04-#12.19SS	SFHP04-#12.19SS-BL		3/4"	
SFHP04-#6.19SS	SFHP04-#6.19SS-BL		3/4"		SFHP04-#12.25SS	SFHP04-#12.25SS-BL		1"	
SFHP04-#6.25SS	SFHP04-#6.25SS-BL		1"		SFHP04-#12.32SS	SFHP04-#12.32SS-BL		1-1/4"	
SFHP04-#6.32SS	SFHP04-#6.32SS-BL		1-1/4"		SFHP04-#12.38SS	SFHP04-#12.38SS-BL		1-1/2"	
SFHP04-#6.38SS	SFHP04-#6.38SS-BL		1-1/2"		SFHP04-#12.50SS	SFHP04-#12.50SS-BL		2"	
SFHP04-#6.50SS	SFHP04-#6.50SS-BL		2"		SFHP04-025.16SS	SFHP04-025.16SS-BL		5/8"	
SFHP04-#8.13SS	SFHP04-#8.13SS-BL	#8	1/2"	50	SFHP04-025.19SS	SFHP04-025.19SS-BL	1/4	3/4"	50
SFHP04-#8.16SS	SFHP04-#8.16SS-BL		5/8"		SFHP04-025.25SS	SFHP04-025.25SS-BL		1"	
SFHP04-#8.19SS	SFHP04-#8.19SS-BL		3/4"		SFHP04-025.32SS	SFHP04-025.32SS-BL		1-1/4"	
SFHP04-#8.25SS	SFHP04-#8.25SS-BL		1"		SFHP04-025.38SS	SFHP04-025.38SS-BL		1-1/2"	
SFHP04-#8.32SS	SFHP04-#8.32SS-BL		1-1/4"		SFHP04-025.50SS	SFHP04-025.50SS-BL		2"	
SFHP04-#8.38SS	SFHP04-#8.38SS-BL		1-1/2"						
SFHP04-#8.50SS	SFHP04-#8.50SS-BL		2"						
SFHP04-#10.13SS	SFHP04-#10.13SS-BL		#10		1/2"	50			
SFHP04-#10.16SS	SFHP04-#10.16SS-BL	5/8"							
SFHP04-#10.19SS	SFHP04-#10.19SS-BL	3/4"							
SFHP04-#10.25SS	SFHP04-#10.25SS-BL	1"							
SFHP04-#10.32SS	SFHP04-#10.32SS-BL	1-1/4"							
SFHP04-#10.38SS	SFHP04-#10.38SS-BL	1-1/2"							
SFHP04-#10.50SS	SFHP04-#10.50SS-BL	2"							



REFER TO 62 PAGES FOR TOOLS







**THEFT RESISTANT SCREW (TRS)**

**TORX BUTTON WITH PIN**

MEASUREMENT: INCH  
 MATERIAL: **STAINLESS STEEL 18-8**  
 FINISH: **PASSIVATED | BLACK | THREAD LOCK**

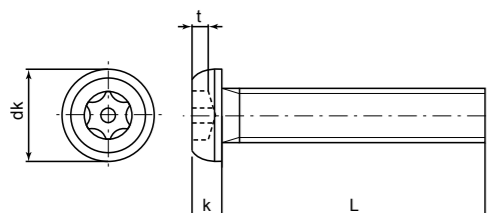

	6-32	8-32	10-24	10-32	1/4-20
dk (REF)	0.262	0.312	0.361	0.361	0.437
k (REF)	0.063	0.087	0.101	0.101	0.132
TOOL SIZE*	T-10	T-15	T-25	T-25	T-27

\*ABOVE DIMENSIONS ARE FOR HEX OR TORX PIN, WITH EXCEPTION TO THE TOOL SIZE

PART NUMBER			D	L	BOX QTY
SST (18-8)	SS + BLACKEN	SST + <b>THREAD LOCK</b>			
SFTP01-#6.037SS	SFTP01-#6.037SS-BK	SFTP01-#6.037SS-NY	6-32	3/8"	50
SFTP01-#6.050SS	SFTP01-#6.050SS-BK	SFTP01-#6.050SS-NY		1/2"	
SFTP01-#6.075SS	SFTP01-#6.075SS-BK	SFTP01-#6.075SS-NY		3/4"	
SFTP01-#6.100SS	SFTP01-#6.100SS-BK	SFTP01-#6.100SS-NY		1"	
SFTP01-#6.150SS	SFTP01-#6.150SS-BK	SFTP01-#6.150SS-NY		1-1/2"	

SFTP01-#8.037SS	SFTP01-#8.037SS-BK	SFTP01-#8.037SS-NY	8-32	3/8"	50
SFTP01-#8.050SS	SFTP01-#8.050SS-BK	SFTP01-#8.050SS-NY		1/2"	
SFTP01-#8.075SS	SFTP01-#8.075SS-BK	SFTP01-#8.075SS-NY		3/4"	
SFTP01-#8.100SS	SFTP01-#8.100SS-BK	SFTP01-#8.100SS-NY		1"	
SFTP01-#8.125SS	SFTP01-#8.125SS-BK	SFTP01-#8.125SS-NY		1-1/4"	
SFTP01-#8.150SS	SFTP01-#8.150SS-BK	SFTP01-#8.150SS-NY		1-1/2"	
SFTP01-#8.175SS	SFTP01-#8.175SS-BK	SFTP01-#8.175SS-NY		1-3/4"	
SFTP01-#8.200SS	SFTP01-#8.200SS-BK	SFTP01-#8.200SS-NY		2"	

SFTP01-#10C.037SS	SFTP01-#10C.037SS-BK	SFTP01-#10C.037SS-NY	10-24	3/8"	25
SFTP01-#10C.050SS	SFTP01-#10C.050SS-BK	SFTP01-#10C.050SS-NY		1/2"	
SFTP01-#10C.062SS	SFTP01-#10C.062SS-BK	SFTP01-#10C.062SS-NY		5/8"	
SFTP01-#10C.075SS	SFTP01-#10C.075SS-BK	SFTP01-#10C.075SS-NY		3/4"	
SFTP01-#10C.100SS	SFTP01-#10C.100SS-BK	SFTP01-#10C.100SS-NY		1"	
SFTP01-#10C.125SS	SFTP01-#10C.125SS-BK	SFTP01-#10C.125SS-NY		1-1/4"	
SFTP01-#10C.150SS	SFTP01-#10C.150SS-BK	SFTP01-#10C.150SS-NY		1-1/2"	

PART NUMBER			D	L	BOX QTY
SST (18-8)	SS + BLACKEN	SST + <b>THREAD LOCK</b>			
SFTP01-#10F.018SS	SFTP01-#10F.018SS-BK	SFTP01-#10F.018SS-NY	10-32	3/16"	25
SFTP01-#10F.037SS	SFTP01-#10F.037SS-BK	SFTP01-#10F.037SS-NY		3/8"	
SFTP01-#10F.050SS	SFTP01-#10F.050SS-BK	SFTP01-#10F.050SS-NY		1/2"	
SFTP01-#10F.062SS	SFTP01-#10F.062SS-BK	SFTP01-#10F.062SS-NY		5/8"	
SFTP01-#10F.075SS	SFTP01-#10F.075SS-BK	SFTP01-#10F.075SS-NY		3/4"	
SFTP01-#10F.100SS	SFTP01-#10F.100SS-BK	SFTP01-#10F.100SS-NY		1"	
SFTP01-#10F.125SS	SFTP01-#10F.125SS-BK	SFTP01-#10F.125SS-NY		1-1/4"	
SFTP01-#10F.150SS	SFTP01-#10F.150SS-BK	SFTP01-#10F.150SS-NY		1-1/2"	

SFTP01-025.025SS	SFTP01-025.025SS-BK	SFTP01-025.025SS-NY	1/4-20	1/4"	25
SFTP01-025.037SS	SFTP01-025.037SS-BK	SFTP01-025.037SS-NY		3/8"	
SFTP01-025.050SS	SFTP01-025.050SS-BK	SFTP01-025.050SS-NY		1/2"	
SFTP01-025.062SS	SFTP01-025.062SS-BK	SFTP01-025.062SS-NY		5/8"	
SFTP01-025.075SS	SFTP01-025.075SS-BK	SFTP01-025.075SS-NY		3/4"	
SFTP01-025.100SS	SFTP01-025.100SS-BK	SFTP01-025.100SS-NY		1"	
SFTP01-025.125SS	SFTP01-025.125SS-BK	SFTP01-025.125SS-NY		1-1/4"	
SFTP01-025.150SS	SFTP01-025.150SS-BK	SFTP01-025.150SS-NY		1-1/2"	
SFTP01-025.175SS	SFTP01-025.175SS-BK	SFTP01-025.175SS-NY		1-3/4"	
SFTP01-025.200SS	SFTP01-025.200SS-BK	SFTP01-025.200SS-NY		2"	

**THREAD LOCKER**

- Reliable, Power Lock
- Multiple Reuse
- Minimizes Galling / Stripping
- Cost Saving

REFER TO 62 PAGES FOR TOOLS





**THEFT RESISTANT SCREW (TRS)**

**TORX FLAT WITH PIN**

MEASUREMENT: INCH  
 MATERIAL: **STAINLESS STEEL 18-8**  
 FINISH: **PASSIVATED | BLACK | THREAD LOCK**

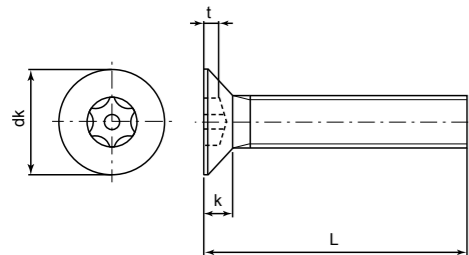

	6-32	8-32	10-24	10-32	1/4-20
dk (REF)	0.307	0.359	0.411	0.411	0.531
k (REF)	0.097	0.112	0.127	0.127	0.161
TOOL SIZE*	T-15	T-20	T-25	T-25	T-30

\*ABOVE DIMENSIONS ARE FOR HEX OR TORX PIN, WITH EXCEPTION TO THE TOOL SIZE

PART NUMBER			D	L	BOX QTY
SST (18-8)	SS + BLACKEN	SST + <b>THREAD LOCK</b>			
SFTP02-#6.037SS	SFTP02-#6.037SS-BK	SFTP02-#6.037SS-NY	6-32	3/8"	50
SFTP02-#6.050SS	SFTP02-#6.050SS-BK	SFTP02-#6.050SS-NY		1/2"	
SFTP02-#6.075SS	SFTP02-#6.075SS-BK	SFTP02-#6.075SS-NY		3/4"	
SFTP02-#6.100SS	SFTP02-#6.100SS-BK	SFTP02-#6.100SS-NY		1"	
SFTP02-#6.150SS	SFTP02-#6.150SS-BK	SFTP02-#6.150SS-NY		1-1/2"	

SFTP02-#8.025SS	SFTP02-#8.025SS-BK	SFTP02-#8.025SS-NY	8-32	1/4"	50
SFTP02-#8.037SS	SFTP02-#8.037SS-BK	SFTP02-#8.037SS-NY		3/8"	
SFTP02-#8.050SS	SFTP02-#8.050SS-BK	SFTP02-#8.050SS-NY		1/2"	
SFTP02-#8.062SS	SFTP02-#8.062SS-BK	SFTP02-#8.062SS-NY		5/8"	
SFTP02-#8.075SS	SFTP02-#8.075SS-BK	SFTP02-#8.075SS-NY		3/4"	
SFTP02-#8.100SS	SFTP02-#8.100SS-BK	SFTP02-#8.100SS-NY		1"	
SFTP02-#8.125SS	SFTP02-#8.125SS-BK	SFTP02-#8.125SS-NY		1-1/4"	
SFTP02-#8.150SS	SFTP02-#8.150SS-BK	SFTP02-#8.150SS-NY		1-1/2"	
SFTP02-#8.200SS	SFTP02-#8.200SS-BK	SFTP02-#8.200SS-NY		2"	

SFTP02-#10C.037SS	SFTP02-#10C.037SS-BK	SFTP02-#10C.037SS-NY	10-24	3/8"	50
SFTP02-#10C.050SS	SFTP02-#10C.050SS-BK	SFTP02-#10C.050SS-NY		1/2"	
SFTP02-#10C.062SS	SFTP02-#10C.062SS-BK	SFTP02-#10C.062SS-NY		5/8"	
SFTP02-#10C.075SS	SFTP02-#10C.075SS-BK	SFTP02-#10C.075SS-NY		3/4"	
SFTP02-#10C.100SS	SFTP02-#10C.100SS-BK	SFTP02-#10C.100SS-NY		1"	
SFTP02-#10C.125SS	SFTP02-#10C.125SS-BK	SFTP02-#10C.125SS-NY		1-1/4"	
SFTP02-#10C.150SS	SFTP02-#10C.150SS-BK	SFTP02-#10C.150SS-NY		1-1/2"	

PART NUMBER			D	L	BOX QTY
SST (18-8)	SS + BLACKEN	SST + <b>THREAD LOCK</b>			
SFTP02-#10F.037SS	SFTP02-#10F.037SS-BK	SFTP02-#10F.037SS-NY	10-32	3/8"	50
SFTP02-#10F.050SS	SFTP02-#10F.050SS-BK	SFTP02-#10F.050SS-NY		1/2"	
SFTP02-#10F.075SS	SFTP02-#10F.075SS-BK	SFTP02-#10F.075SS-NY		3/4"	
SFTP02-#10F.100SS	SFTP02-#10F.100SS-BK	SFTP02-#10F.100SS-NY		1"	
SFTP02-#10F.125SS	SFTP02-#10F.125SS-BK	SFTP02-#10F.125SS-NY		1-1/4"	
SFTP02-#10F.150SS	SFTP02-#10F.150SS-BK	SFTP02-#10F.150SS-NY		1-1/2"	

SFTP02-025.037SS	SFTP02-025.037SS-BK	SFTP02-025.037SS-NY	1/4-20	3/8"	25
SFTP02-025.050SS	SFTP02-025.050SS-BK	SFTP02-025.050SS-NY		1/2"	
SFTP02-025.062SS	SFTP02-025.062SS-BK	SFTP02-025.062SS-NY		5/8"	
SFTP02-025.075SS	SFTP02-025.075SS-BK	SFTP02-025.075SS-NY		3/4"	
SFTP02-025.100SS	SFTP02-025.100SS-BK	SFTP02-025.100SS-NY		1"	
SFTP02-025.125SS	SFTP02-025.125SS-BK	SFTP02-025.125SS-NY		1-1/4"	
SFTP02-025.150SS	SFTP02-025.150SS-BK	SFTP02-025.150SS-NY		1-1/2"	
SFTP02-025.175SS	SFTP02-025.175SS-BK	SFTP02-025.175SS-NY		1-3/4"	
SFTP02-025.200SS	SFTP02-025.200SS-BK	SFTP02-025.200SS-NY		2"	
SFTP02-025.250SS	SFTP02-025.250SS-BK	SFTP02-025.250SS-NY		2-1/2"	

**THREAD LOCKER**

- Reliable, Power Lock
- Multiple Reuse
- Minimizes Galling / Stripping
- Cost Saving

REFER TO 62 PAGES FOR TOOLS





**THEFT RESISTANT SCREW (TRS)**

**TORX PIN BUTTON HEAD SHEET METAL SCREW TYPE AB**

MEASUREMENT: INCH  
 MATERIAL: **STAINLESS STEEL 18-8**  
 FINISH: **PASSIVATED | BLACK**

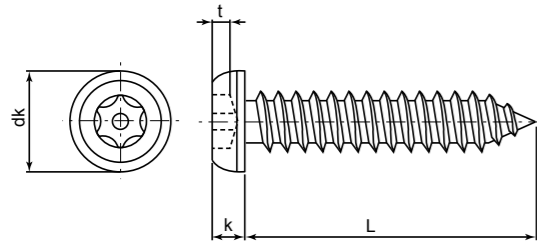

	3.5 (#6)	4.2 (#8)	4.8 (#10)	5.5 (#12)	6.3 (1/4)
dk	0.22	0.30	0.37	0.39	0.41
k	0.06	0.09	0.11	0.11	0.13
s	TX10	TX15	TX25	TX27	TX27

PART NUMBER		D	L	BOX QTY	PART NUMBER		D	L	BOX QTY
SST (18-8)	SS + BLACKEN				SST (18-8)	SS + BLACKEN			
SFTP03-#6.13SS	SFTP03-#6.13SS-BL	#6	1/2"	50	SFTP03-#12.13SS	SFTP03-#12.13SS-BL	#12	1/2"	50
SFTP03-#6.19SS	SFTP03-#6.19SS-BL		3/4"		SFTP03-#12.19SS	SFTP03-#12.19SS-BL		3/4"	
SFTP03-#6.25SS	SFTP03-#6.25SS-BL		1"		SFTP03-#12.25SS	SFTP03-#12.25SS-BL		1"	
SFTP03-#6.32SS	SFTP03-#6.32SS-BL		1-1/4"		SFTP03-#12.32SS	SFTP03-#12.32SS-BL		1-1/4"	
SFTP03-#6.38SS	SFTP03-#6.38SS-BL		1-1/2"		SFTP03-#12.38SS	SFTP03-#12.38SS-BL		1-1/2"	
SFTP03-#8.13SS	SFTP03-#8.13SS-BL	#8	1/2"	50	SFTP03-#12.50SS	SFTP03-#12.50SS-BL	#12	2"	50
SFTP03-#8.19SS	SFTP03-#8.19SS-BL		3/4"		SFTP03-#12.63SS	SFTP03-#12.63SS-BL		2-1/2"	
SFTP03-#8.25SS	SFTP03-#8.25SS-BL		1"		SFTP03-#12.75SS	SFTP03-#12.75SS-BL		3"	
SFTP03-#8.32SS	SFTP03-#8.32SS-BL		1-1/4"		SFTP03-025.13SS	SFTP03-025.13SS-BL		1/2"	
SFTP03-#8.38SS	SFTP03-#8.38SS-BL	1-1/2"	SFTP03-025.19SS	SFTP03-025.19SS-BL	3/4"	#10	1"	50	
SFTP03-#10.13SS	SFTP03-#10.13SS-BL	1/2"	SFTP03-025.25SS	SFTP03-025.25SS-BL	1-1/4"				
SFTP03-#10.19SS	SFTP03-#10.19SS-BL	3/4"	SFTP03-025.32SS	SFTP03-025.32SS-BL	1-1/2"				
SFTP03-#10.25SS	SFTP03-#10.25SS-BL	1"	SFTP03-025.38SS	SFTP03-025.38SS-BL	2"				
SFTP03-#10.32SS	SFTP03-#10.32SS-BL	1-1/4"	SFTP03-025.50SS	SFTP03-025.50SS-BL					
SFTP03-#10.38SS	SFTP03-#10.38SS-BL	1-1/2"							
SFTP03-#10.50SS	SFTP03-#10.50SS-BL	2"							



**THEFT RESISTANT SCREW (TRS)**

**TORX PIN FLAT HEAD SHEET METAL SCREW TYPE AB**

MEASUREMENT: INCH  
 MATERIAL: **STAINLESS STEEL 18-8**  
 FINISH: **PASSIVATED | BLACK**

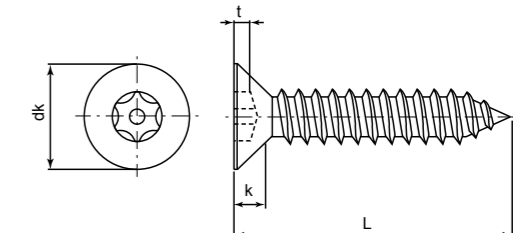

	3.5 (#6)	4.2 (#8)	4.8 (#10)	5.5 (#12)	6.3 (1/4)
dk	0.27	0.32	0.37	0.43	0.49
k	0.08	0.10	0.12	0.14	0.16
s	TX15	TX20	TX25	TX27	TX30

PART NUMBER		D	L	BOX QTY	PART NUMBER		D	L	BOX QTY
SST (18-8)	SS + BLACKEN				SST (18-8)	SS + BLACKEN			
SFTP04-#6.13SS	SFTP04-#6.13SS-BL	#6	1/2"	50	SFTP04-#12.13SS	SFTP04-#12.13SS-BL	#12	1/2"	50
SFTP04-#6.16SS	SFTP04-#6.16SS-BL		5/8"		SFTP04-#12.16SS	SFTP04-#12.16SS-BL		5/8"	
SFTP04-#6.19SS	SFTP04-#6.19SS-BL		3/4"		SFTP04-#12.19SS	SFTP04-#12.19SS-BL		3/4"	
SFTP04-#6.25SS	SFTP04-#6.25SS-BL		1"		SFTP04-#12.25SS	SFTP04-#12.25SS-BL		1"	
SFTP04-#6.32SS	SFTP04-#6.32SS-BL		1-1/4"		SFTP04-#12.32SS	SFTP04-#12.32SS-BL		1-1/4"	
SFTP04-#6.38SS	SFTP04-#6.38SS-BL	1-1/2"	SFTP04-#12.38SS	SFTP04-#12.38SS-BL	1-1/2"	#8	2"	50	
SFTP04-#8.13SS	SFTP04-#8.13SS-BL	1/2"	SFTP04-#12.50SS	SFTP04-#12.50SS-BL	2"				
SFTP04-#8.16SS	SFTP04-#8.16SS-BL	5/8"	SFTP04-#12.63SS	SFTP04-#12.63SS-BL	2-1/2"				
SFTP04-#8.19SS	SFTP04-#8.19SS-BL	3/4"	SFTP04-#12.75SS	SFTP04-#12.75SS-BL	3"				
SFTP04-#8.25SS	SFTP04-#8.25SS-BL	1"	SFTP04-025.16SS	SFTP04-025.16SS-BL	5/8"				
SFTP04-#8.32SS	SFTP04-#8.32SS-BL	1-1/4"	SFTP04-025.19SS	SFTP04-025.19SS-BL	3/4"	#10	1"	50	
SFTP04-#8.38SS	SFTP04-#8.38SS-BL	1-1/2"	SFTP04-025.25SS	SFTP04-025.25SS-BL	1-1/4"				
SFTP04-#10.13SS	SFTP04-#10.13SS-BL	1/2"	SFTP04-025.32SS	SFTP04-025.32SS-BL	1-1/2"				
SFTP04-#10.16SS	SFTP04-#10.16SS-BL	5/8"	SFTP04-025.38SS	SFTP04-025.38SS-BL	2"				
SFTP04-#10.19SS	SFTP04-#10.19SS-BL	3/4"	SFTP04-025.50SS	SFTP04-025.50SS-BL					
SFTP04-#10.25SS	SFTP04-#10.25SS-BL	1"							
SFTP04-#10.32SS	SFTP04-#10.32SS-BL	1-1/4"							
SFTP04-#10.38SS	SFTP04-#10.38SS-BL	1-1/2"							
SFTP04-#10.50SS	SFTP04-#10.50SS-BL	2"							

REFER TO 62 PAGES FOR TOOLS







**THEFT RESISTANT SCREW (TRS)**

**DRILLED SPANNER PAN HEAD MACHINE SCREW**

MEASUREMENT: INCH  
 MATERIAL: **STAINLESS STEEL 18-8**  
 FINISH: **PASSIVATED | BLACK | THREAD LOCK**

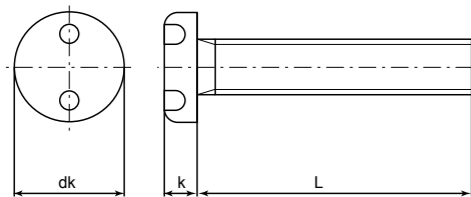

	4-40	6-32	8-32	10-24	10-32	1/4-20
dk (REF)	0.219	0.27	0.322	0.373	0.373	0.492
k (REF)	0.068	0.082	0.096	0.110	0.110	0.144
TOOL SIZE*	SP4	SP6	SP8	SP10	SP10	SP14

PART NUMBER			D	L	BOX QTY
SST (18-8)	SS + BLACKEN	SST + <b>THREAD LOCK</b>			
SFDS01-#4.025SS	SFDS01-#4.025SS-BK	SFDS01-#4.025SS-NY	4-40	1/4"	50
SFDS01-#4.037SS	SFDS01-#4.037SS-BK	SFDS01-#4.037SS-NY		3/8"	
SFDS01-#4.050SS	SFDS01-#4.050SS-BK	SFDS01-#4.050SS-NY		1/2"	
SFDS01-#4.062SS	SFDS01-#4.062SS-BK	SFDS01-#4.062SS-NY		5/8"	
SFDS01-#4.075SS	SFDS01-#4.075SS-BK	SFDS01-#4.075SS-NY		3/4"	
SFDS01-#4.100SS	SFDS01-#4.100SS-BK	SFDS01-#4.100SS-NY		1"	
SFDS01-#4.125SS	SFDS01-#4.125SS-BK	SFDS01-#4.125SS-NY		1-1/4"	
SFDS01-#4.150SS	SFDS01-#4.150SS-BK	SFDS01-#4.150SS-NY		1-1/2"	

SFDS01-#6.025SS	SFDS01-#6.025SS-BK	SFDS01-#6.025SS-NY	6-32	1/4"	50
SFDS01-#6.037SS	SFDS01-#6.037SS-BK	SFDS01-#6.037SS-NY		3/8"	
SFDS01-#6.050SS	SFDS01-#6.050SS-BK	SFDS01-#6.050SS-NY		1/2"	
SFDS01-#6.062SS	SFDS01-#6.062SS-BK	SFDS01-#6.062SS-NY		5/8"	
SFDS01-#6.075SS	SFDS01-#6.075SS-BK	SFDS01-#6.075SS-NY		3/4"	
SFDS01-#6.100SS	SFDS01-#6.100SS-BK	SFDS01-#6.100SS-NY		1"	
SFDS01-#6.125SS	SFDS01-#6.125SS-BK	SFDS01-#6.125SS-NY		1-1/4"	
SFDS01-#6.150SS	SFDS01-#6.150SS-BK	SFDS01-#6.150SS-NY		1-1/2"	
SFDS01-#6.200SS	SFDS01-#6.200SS-BK	SFDS01-#6.200SS-NY		2"	
SFDS01-#6.300SS	SFDS01-#6.300SS-BK	SFDS01-#6.300SS-NY		3"	

SFDS01-#8.025SS	SFDS01-#8.025SS-BK	SFDS01-#8.025SS-NY	8-32	1/4"	50
SFDS01-#8.037SS	SFDS01-#8.037SS-BK	SFDS01-#8.037SS-NY		3/8"	
SFDS01-#8.050SS	SFDS01-#8.050SS-BK	SFDS01-#8.050SS-NY		1/2"	
SFDS01-#8.062SS	SFDS01-#8.062SS-BK	SFDS01-#8.062SS-NY		5/8"	
SFDS01-#8.075SS	SFDS01-#8.075SS-BK	SFDS01-#8.075SS-NY		3/4"	
SFDS01-#8.100SS	SFDS01-#8.100SS-BK	SFDS01-#8.100SS-NY		1"	
SFDS01-#8.125SS	SFDS01-#8.125SS-BK	SFDS01-#8.125SS-NY		1-1/4"	
SFDS01-#8.150SS	SFDS01-#8.150SS-BK	SFDS01-#8.150SS-NY		1-1/2"	
SFDS01-#8.200SS	SFDS01-#8.200SS-BK	SFDS01-#8.200SS-NY		2"	

PART NUMBER			D	L	BOX QTY
SST (18-8)	SS + BLACKEN	SST + <b>THREAD LOCK</b>			
SFDS01-#10C.037SS	SFDS01-#10C.037SS-BK	SFDS01-#10C.037SS-NY	10-24	3/8"	25
SFDS01-#10C.050SS	SFDS01-#10C.050SS-BK	SFDS01-#10C.050SS-NY		1/2"	
SFDS01-#10C.062SS	SFDS01-#10C.062SS-BK	SFDS01-#10C.062SS-NY		5/8"	
SFDS01-#10C.075SS	SFDS01-#10C.075SS-BK	SFDS01-#10C.075SS-NY		3/4"	
SFDS01-#10C.100SS	SFDS01-#10C.100SS-BK	SFDS01-#10C.100SS-NY		1"	
SFDS01-#10C.150SS	SFDS01-#10C.150SS-BK	SFDS01-#10C.150SS-NY		1-1/2"	
SFDS01-#10C.175SS	SFDS01-#10C.175SS-BK	SFDS01-#10C.175SS-NY		1-3/4"	
SFDS01-#10C.200SS	SFDS01-#10C.200SS-BK	SFDS01-#10C.200SS-NY		2"	
SFDS01-#10C.250SS	SFDS01-#10C.250SS-BK	SFDS01-#10C.250SS-NY		2-1/2"	
SFDS01-#10C.400SS	SFDS01-#10C.400SS-BK	SFDS01-#10C.400SS-NY		4"	

SFDS01-#10F.025SS	SFDS01-#10F.025SS-BK	SFDS01-#10F.025SS-NY	10-32	1/4"	25
SFDS01-#10F.037SS	SFDS01-#10F.037SS-BK	SFDS01-#10F.037SS-NY		3/8"	
SFDS01-#10F.050SS	SFDS01-#10F.050SS-BK	SFDS01-#10F.050SS-NY		1/2"	
SFDS01-#10F.062SS	SFDS01-#10F.062SS-BK	SFDS01-#10F.062SS-NY		5/8"	
SFDS01-#10F.075SS	SFDS01-#10F.075SS-BK	SFDS01-#10F.075SS-NY		3/4"	
SFDS01-#10F.100SS	SFDS01-#10F.100SS-BK	SFDS01-#10F.100SS-NY		1"	
SFDS01-#10F.125SS	SFDS01-#10F.125SS-BK	SFDS01-#10F.125SS-NY		1-1/4"	
SFDS01-#10F.150SS	SFDS01-#10F.150SS-BK	SFDS01-#10F.150SS-NY		1-1/2"	
SFDS01-#10F.200SS	SFDS01-#10F.200SS-BK	SFDS01-#10F.200SS-NY		2"	
SFDS01-#10F.250SS	SFDS01-#10F.250SS-BK	SFDS01-#10F.250SS-NY		2-1/2"	
SFDS01-#10F.400SS	SFDS01-#10F.400SS-BK	SFDS01-#10F.400SS-NY	4"		

SFDS01-025.037SS	SFDS01-025.037SS-BK	SFDS01-025.037SS-NY	1/4-20	3/8"	25
SFDS01-025.050SS	SFDS01-025.050SS-BK	SFDS01-025.050SS-NY		1/2"	
SFDS01-025.062SS	SFDS01-025.062SS-BK	SFDS01-025.062SS-NY		5/8"	
SFDS01-025.075SS	SFDS01-025.075SS-BK	SFDS01-025.075SS-NY		3/4"	
SFDS01-025.100SS	SFDS01-025.100SS-BK	SFDS01-025.100SS-NY		1"	
SFDS01-025.125SS	SFDS01-025.125SS-BK	SFDS01-025.125SS-NY		1-1/4"	
SFDS01-025.150SS	SFDS01-025.150SS-BK	SFDS01-025.150SS-NY		1-1/2"	
SFDS01-025.200SS	SFDS01-025.200SS-BK	SFDS01-025.200SS-NY		2"	
SFDS01-025.250SS	SFDS01-025.250SS-BK	SFDS01-025.250SS-NY		2-1/2"	
SFDS01-025.300SS	SFDS01-025.300SS-BK	SFDS01-025.300SS-NY		3"	
SFDS01-025.400SS	SFDS01-025.400SS-BK	SFDS01-025.400SS-NY	4"		

**THREAD LOCKER**

- Reliable, Power Lock
- Multiple Reuse
- Minimizes Galling / Stripping
- Cost Saving

REFER TO 62 PAGES FOR TOOLS





**THEFT RESISTANT SCREW (TRS)**

**DRILLED SPANNER FLAT HEAD MACHINE SCREW**

MEASUREMENT: INCH  
 MATERIAL: **STAINLESS STEEL 18-8**  
 FINISH: **PASSIVATED | BLACK | THREAD LOCK**

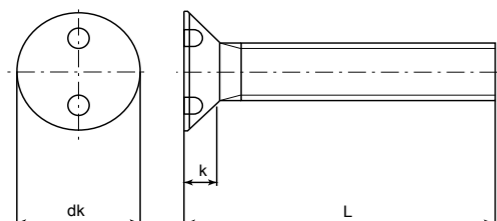

	4-40	6-32	8-32	10-24	10-32	1/4-20
dk (REF)	0.225	0.279	0.332	0.385	0.385	0.507
k (REF)	0.067	0.083	0.100	0.116	0.116	0.153
TOOL SIZE*	SP4	SP6	SP8	SP10	SP10	SP14

PART NUMBER			D	L	BOX QTY
SST (18-8)	SS + BLACKEN	SST + <b>THREAD LOCK</b>			
SFDS02-#4.025SS	SFDS02-#4.025SS-BK	SFDS02-#4.025SS-NY	4-40	1/4"	50
SFDS02-#4.037SS	SFDS02-#4.037SS-BK	SFDS02-#4.037SS-NY		3/8"	
SFDS02-#4.050SS	SFDS02-#4.050SS-BK	SFDS02-#4.050SS-NY		1/2"	
SFDS02-#4.062SS	SFDS02-#4.062SS-BK	SFDS02-#4.062SS-NY		5/8"	
SFDS02-#4.075SS	SFDS02-#4.075SS-BK	SFDS02-#4.075SS-NY		3/4"	
SFDS02-#4.100SS	SFDS02-#4.100SS-BK	SFDS02-#4.100SS-NY		1"	
SFDS02-#4.125SS	SFDS02-#4.125SS-BK	SFDS02-#4.125SS-NY		1-1/4"	
SFDS02-#4.150SS	SFDS02-#4.150SS-BK	SFDS02-#4.150SS-NY		1-1/2"	

SFDS02-#6.025SS	SFDS02-#6.025SS-BK	SFDS02-#6.025SS-NY	6-32	1/4"	50
SFDS02-#6.037SS	SFDS02-#6.037SS-BK	SFDS02-#6.037SS-NY		3/8"	
SFDS02-#6.050SS	SFDS02-#6.050SS-BK	SFDS02-#6.050SS-NY		1/2"	
SFDS02-#6.062SS	SFDS02-#6.062SS-BK	SFDS02-#6.062SS-NY		5/8"	
SFDS02-#6.075SS	SFDS02-#6.075SS-BK	SFDS02-#6.075SS-NY		3/4"	
SFDS02-#6.100SS	SFDS02-#6.100SS-BK	SFDS02-#6.100SS-NY		1"	
SFDS02-#6.125SS	SFDS02-#6.125SS-BK	SFDS02-#6.125SS-NY		1-1/4"	
SFDS02-#6.150SS	SFDS02-#6.150SS-BK	SFDS02-#6.150SS-NY		1-1/2"	
SFDS02-#6.200SS	SFDS02-#6.200SS-BK	SFDS02-#6.200SS-NY		2"	
SFDS01-#6.300SS	SFDS01-#6.300SS-BK	SFDS01-#6.300SS-NY		3"	

SFDS02-#8.037SS	SFDS02-#8.037SS-BK	SFDS02-#8.037SS-NY	8-32	3/8"	50
SFDS02-#8.050SS	SFDS02-#8.050SS-BK	SFDS02-#8.050SS-NY		1/2"	
SFDS02-#8.062SS	SFDS02-#8.062SS-BK	SFDS02-#8.062SS-NY		5/8"	
SFDS02-#8.075SS	SFDS02-#8.075SS-BK	SFDS02-#8.075SS-NY		3/4"	
SFDS02-#8.100SS	SFDS02-#8.100SS-BK	SFDS02-#8.100SS-NY		1"	
SFDS02-#8.125SS	SFDS02-#8.125SS-BK	SFDS02-#8.125SS-NY		1-1/4"	
SFDS02-#8.200SS	SFDS02-#8.200SS-BK	SFDS02-#8.200SS-NY		2"	

PART NUMBER			D	L	BOX QTY
SST (18-8)	SS + BLACKEN	SST + <b>THREAD LOCK</b>			
SFDS02-#10C.037SS	SFDS02-#10C.037SS-BK	SFDS02-#10C.037SS-NY	10-24	3/8"	25
SFDS02-#10C.050SS	SFDS02-#10C.050SS-BK	SFDS02-#10C.050SS-NY		1/2"	
SFDS02-#10C.062SS	SFDS02-#10C.062SS-BK	SFDS02-#10C.062SS-NY		5/8"	
SFDS02-#10C.075SS	SFDS02-#10C.075SS-BK	SFDS02-#10C.075SS-NY		3/4"	
SFDS02-#10C.087SS	SFDS02-#10C.087SS-BK	SFDS02-#10C.087SS-NY		7/8"	
SFDS02-#10C.100SS	SFDS02-#10C.100SS-BK	SFDS02-#10C.100SS-NY		1"	
SFDS02-#10C.150SS	SFDS02-#10C.150SS-BK	SFDS02-#10C.150SS-NY		1-1/2"	
SFDS02-#10C.175SS	SFDS02-#10C.175SS-BK	SFDS02-#10C.175SS-NY		1-3/4"	
SFDS02-#10C.200SS	SFDS02-#10C.200SS-BK	SFDS02-#10C.200SS-NY		2"	

SFDS02-#10F.037SS	SFDS02-#10F.037SS-BK	SFDS02-#10F.037SS-NY	10-32	3/8"	25
SFDS02-#10F.050SS	SFDS02-#10F.050SS-BK	SFDS02-#10F.050SS-NY		1/2"	
SFDS02-#10F.062SS	SFDS02-#10F.062SS-BK	SFDS02-#10F.062SS-NY		5/8"	
SFDS02-#10F.075SS	SFDS02-#10F.075SS-BK	SFDS02-#10F.075SS-NY		3/4"	
SFDS02-#10F.087SS	SFDS02-#10F.087SS-BK	SFDS02-#10F.087SS-NY		7/8"	
SFDS02-#10F.100SS	SFDS02-#10F.100SS-BK	SFDS02-#10F.100SS-NY		1"	
SFDS02-#10F.125SS	SFDS02-#10F.125SS-BK	SFDS02-#10F.125SS-NY		1-1/4"	
SFDS02-#10F.150SS	SFDS02-#10F.150SS-BK	SFDS02-#10F.150SS-NY		1-1/2"	
SFDS02-#10F.200SS	SFDS02-#10F.200SS-BK	SFDS02-#10F.200SS-NY		2"	
SFDS02-#10F.250SS	SFDS02-#10F.250SS-BK	SFDS02-#10F.250SS-NY		2-1/2"	

SFDS02-025.037SS	SFDS02-025.037SS-BK	SFDS02-025.037SS-NY	1/4-20	3/8"	25
SFDS02-025.050SS	SFDS02-025.050SS-BK	SFDS02-025.050SS-NY		1/2"	
SFDS02-025.062SS	SFDS02-025.062SS-BK	SFDS02-025.062SS-NY		5/8"	
SFDS02-025.075SS	SFDS02-025.075SS-BK	SFDS02-025.075SS-NY		3/4"	
SFDS02-025.100SS	SFDS02-025.100SS-BK	SFDS02-025.100SS-NY		1"	
SFDS02-025.125SS	SFDS02-025.125SS-BK	SFDS02-025.125SS-NY		1-1/4"	
SFDS02-025.150SS	SFDS02-025.150SS-BK	SFDS02-025.150SS-NY		1-1/2"	
SFDS02-025.200SS	SFDS02-025.200SS-BK	SFDS02-025.200SS-NY		2"	
SFDS02-025.250SS	SFDS02-025.250SS-BK	SFDS02-025.250SS-NY		2-1/2"	

**THREAD LOCKER**

- Reliable, Power Lock
- Multiple Reuse
- Minimizes Galling / Stripping
- Cost Saving

REFER TO 62 PAGES FOR TOOLS



**THEFT RESISTANT SCREW (TRS)**



**DRILLED SPANNER PAN HEAD SHEET METAL SCREW  
TYPE AB**

MEASUREMENT: INCH  
MATERIAL: **STAINLESS STEEL 18-8**  
FINISH: **PASSIVATED | BLACK**

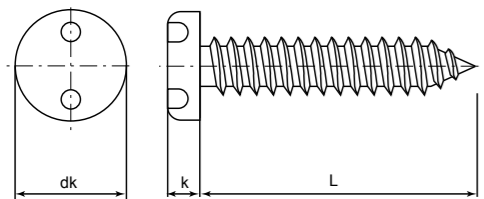

	2.9 (#4)	3.5 (#6)	4.2 (#8)	4.8 (#10)	5.5 (#12)	6.3 (1/4")
dk	0.22	0.22	0.30	0.37	0.41	0.49
k	0.06	0.06	0.09	0.11	0.13	0.13
Drive Size	SP4	SP6	SP8	SP10	SP12	SP14

PART NUMBER		D	L	BOX QTY	PART NUMBER		D	L	BOX QTY
SST (18-8)	SS + BLACKEN				SST (18-8)	SS + BLACKEN			
SFDS03-#4.065SS	SFDS03-#4.065SS-BL	#4	1/4"	50	SFDS03-#10.095SS	SFDS03-#10.095SS-BL	#10	3/8"	50
SFDS03-#4.095SS	SFDS03-#4.095SS-BL		3/8"		SFDS03-#10.13SS	SFDS03-#10.13SS-BL		1/2"	
SFDS03-#4.13SS	SFDS03-#4.13SS-BL		1/2"		SFDS03-#10.16SS	SFDS03-#10.16SS-BL		5/8"	
SFDS03-#4.16SS	SFDS03-#4.16SS-BL		5/8"		SFDS03-#10.19SS	SFDS03-#10.19SS-BL		3/4"	
SFDS03-#4.19SS	SFDS03-#4.19SS-BL		3/4"		SFDS03-#10.25SS	SFDS03-#10.25SS-BL		1"	
SFDS03-#4.25SS	SFDS03-#4.25SS-BL		1"		SFDS03-#10.32SS	SFDS03-#10.32SS-BL		1-1/4"	
SFDS03-#6.065SS	SFDS03-#6.065SS-BL	#6	1/4"	50	SFDS03-#10.38SS	SFDS03-#10.38SS-BL	#12	1-1/2"	50
SFDS03-#6.095SS	SFDS03-#6.095SS-BL		3/8"		SFDS03-#10.45SS	SFDS03-#10.45SS-BL		1-3/4"	
SFDS03-#6.13SS	SFDS03-#6.13SS-BL		1/2"		SFDS03-#10.50SS	SFDS03-#10.50SS-BL		2"	
SFDS03-#6.16SS	SFDS03-#6.16SS-BL		5/8"		SFDS03-#12.13SS	SFDS03-#12.13SS-BL		1/2"	
SFDS03-#6.19SS	SFDS03-#6.19SS-BL		3/4"		SFDS03-#12.16SS	SFDS03-#12.16SS-BL		5/8"	
SFDS03-#6.25SS	SFDS03-#6.25SS-BL		1"		SFDS03-#12.19SS	SFDS03-#12.19SS-BL		3/4"	
SFDS03-#6.32SS	SFDS03-#6.32SS-BL	#8	1-1/4"	50	SFDS03-#12.25SS	SFDS03-#12.25SS-BL	1/4"	1"	50
SFDS03-#6.38SS	SFDS03-#6.38SS-BL		1-1/2"		SFDS03-#12.32SS	SFDS03-#12.32SS-BL		1-1/4"	
SFDS03-#6.45SS	SFDS03-#6.45SS-BL		1-3/4"		SFDS03-#12.38SS	SFDS03-#12.38SS-BL		1-1/2"	
SFDS03-#6.50SS	SFDS03-#6.50SS-BL		2"		SFDS03-#12.45SS	SFDS03-#12.45SS-BL		1-3/4"	
SFDS03-#8.095SS	SFDS03-#8.095SS-BL		3/8"		SFDS03-#12.50SS	SFDS03-#12.50SS-BL		2"	
SFDS03-#8.13SS	SFDS03-#8.13SS-BL		1/2"		SFDS03-025.13SS	SFDS03-025.13SS-BL		1/2"	
SFDS03-#8.16SS	SFDS03-#8.16SS-BL	#8	5/8"	50	SFDS03-025.19SS	SFDS03-025.19SS-BL	1/4"	5/8"	50
SFDS03-#8.19SS	SFDS03-#8.19SS-BL		3/4"		SFDS03-025.25SS	SFDS03-025.25SS-BL		1"	
SFDS03-#8.25SS	SFDS03-#8.25SS-BL		1"		SFDS03-025.32SS	SFDS03-025.32SS-BL		1-1/4"	
SFDS03-#8.32SS	SFDS03-#8.32SS-BL		1-1/4"		SFDS03-025.38SS	SFDS03-025.38SS-BL		1-1/2"	
SFDS03-#8.38SS	SFDS03-#8.38SS-BL		1-1/2"		SFDS03-025.45SS	SFDS03-025.45SS-BL		1-3/4"	
SFDS03-#8.45SS	SFDS03-#8.45SS-BL		1-3/4"		SFDS03-025.50SS	SFDS03-025.50SS-BL		2"	
SFDS03-#8.50SS	SFDS03-#8.50SS-BL	2"							



**THEFT RESISTANT SCREW (TRS)**

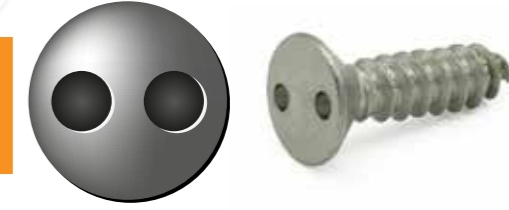

**DRILLED SPANNER FLAT HEAD SHEET METAL SCREW  
TYPE AB**

MEASUREMENT: INCH  
MATERIAL: **STAINLESS STEEL 18-8**  
FINISH: **PASSIVATED | BLACK**

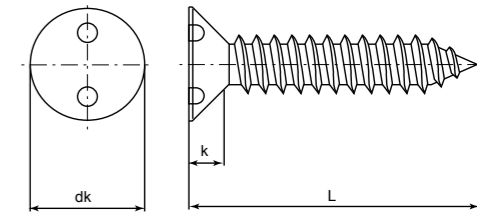

	2.9 (#4)	3.5 (#6)	4.2 (#8)	4.8 (#10)	5.5 (#12)	6.3 (1/4")
dk	0.22	0.27	0.32	0.37	0.43	0.49
k	0.07	0.08	0.10	0.12	0.14	0.16
Drive Size	SP4	SP6	SP8	SP10	SP12	SP14

PART NUMBER		D	L	BOX QTY	PART NUMBER		D	L	BOX QTY
SST (18-8)	SS + BLACKEN				SST (18-8)	SS + BLACKEN			
SFDS04-#4.065SS	SFDS04-#4.065SS-BL	#4	1/4"	50	SFDS04-#10.13SS	SFDS04-#10.13SS-BL	#10	1/2"	50
SFDS04-#4.095SS	SFDS04-#4.095SS-BL		3/8"		SFDS04-#10.16SS	SFDS04-#10.16SS-BL		5/8"	
SFDS04-#4.13SS	SFDS04-#4.13SS-BL		1/2"		SFDS04-#10.19SS	SFDS04-#10.19SS-BL		3/4"	
SFDS04-#4.16SS	SFDS04-#4.16SS-BL		5/8"		SFDS04-#10.25SS	SFDS04-#10.25SS-BL		1"	
SFDS04-#4.19SS	SFDS04-#4.19SS-BL		3/4"		SFDS04-#10.32SS	SFDS04-#10.32SS-BL		1-1/4"	
SFDS04-#4.25SS	SFDS04-#4.25SS-BL		1"		SFDS04-#10.38SS	SFDS04-#10.38SS-BL		1-1/2"	
SFDS04-#6.095SS	SFDS04-#6.095SS-BL	#6	3/8"	50	SFDS04-#10.45SS	SFDS04-#10.45SS-BL	#12	1-3/4"	50
SFDS04-#6.13SS	SFDS04-#6.13SS-BL		1/2"		SFDS04-#10.50SS	SFDS04-#10.50SS-BL		2"	
SFDS04-#6.16SS	SFDS04-#6.16SS-BL		5/8"		SFDS04-#12.13SS	SFDS04-#12.13SS-BL		1/2"	
SFDS04-#6.19SS	SFDS04-#6.19SS-BL		3/4"		SFDS04-#12.16SS	SFDS04-#12.16SS-BL		5/8"	
SFDS04-#6.25SS	SFDS04-#6.25SS-BL		1"		SFDS04-#12.19SS	SFDS04-#12.19SS-BL		3/4"	
SFDS04-#6.32SS	SFDS04-#6.32SS-BL		1-1/4"		SFDS04-#12.25SS	SFDS04-#12.25SS-BL		1"	
SFDS04-#6.38SS	SFDS04-#6.38SS-BL	#8	1-1/2"	50	SFDS04-#12.32SS	SFDS04-#12.32SS-BL	1/4"	1-1/4"	50
SFDS04-#6.45SS	SFDS04-#6.45SS-BL		1-3/4"		SFDS04-#12.38SS	SFDS04-#12.38SS-BL		1-1/2"	
SFDS04-#8.095SS	SFDS04-#8.095SS-BL		3/8"		SFDS04-#12.45SS	SFDS04-#12.45SS-BL		1-3/4"	
SFDS04-#8.13SS	SFDS04-#8.13SS-BL		1/2"		SFDS04-#12.50SS	SFDS04-#12.50SS-BL		2"	
SFDS04-#8.16SS	SFDS04-#8.16SS-BL		5/8"		SFDS04-025.13SS	SFDS04-025.13SS-BL		1/2"	
SFDS04-#8.19SS	SFDS04-#8.19SS-BL		3/4"		SFDS04-025.19SS	SFDS04-025.19SS-BL		3/4"	
SFDS04-#8.25SS	SFDS04-#8.25SS-BL	#8	1"	50	SFDS04-025.25SS	SFDS04-025.25SS-BL	1/4"	1"	50
SFDS04-#8.32SS	SFDS04-#8.32SS-BL		1-1/4"		SFDS04-025.32SS	SFDS04-025.32SS-BL		1-1/4"	
SFDS04-#8.38SS	SFDS04-#8.38SS-BL		1-1/2"		SFDS04-025.38SS	SFDS04-025.38SS-BL		1-1/2"	
SFDS04-#8.45SS	SFDS04-#8.45SS-BL		1-3/4"		SFDS04-025.45SS	SFDS04-025.45SS-BL		1-3/4"	
SFDS04-#8.50SS	SFDS04-#8.50SS-BL		2"		SFDS04-025.50SS	SFDS04-025.50SS-BL		2"	



REFER TO 62 PAGES FOR TOOLS





## TOOLS - BITS & KEYS - INCH



**HP BIT FOR TRS**  
[SOCKET PIN USE - INCH]

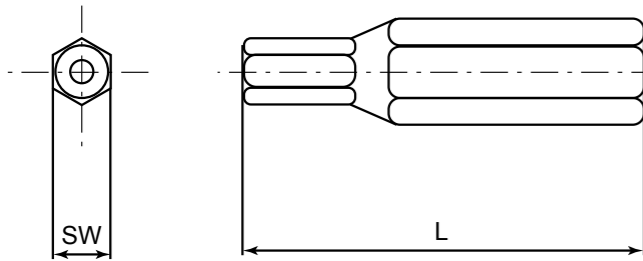

SIZE	PART NUMBER	QTY	SHANK FIT
3/32"	SFHP332B	1	1/4"
1/8"	SFHP018B		1/4"
9/64"	SFHP964B		1/4"
5/32"	SFHP532B		1/4"
3/16"	SFHP316B		1/4"
7/32"	SFHP732B		1/4"
1/4"	SFHP014B		1/4"
5/16"	SFHP516B		1/4"
3/8"	SFHP038B		1/4"



**TP BIT FOR TRS**  
[TORX PIN USE - INCH]

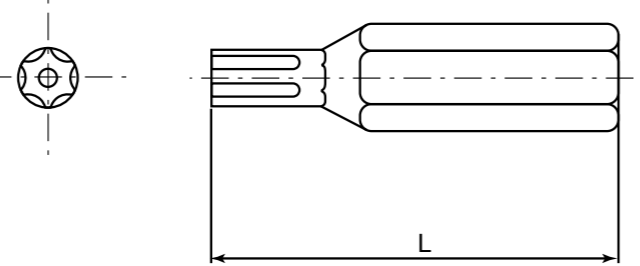

SIZE	PART NUMBER	QTY	SHANK FIT
T6	SFTP06B	1	1/4"
T8	SFTP08B		
T10	SFTP10B		
T15	SFTP15B		
T20	SFTP20B		
T25	SFTP25B		
T27	SFTP27B		
T30	SFTP30B		
T40	SFTP40B		
T45	SFTP45B		



**HP BIT FOR TRS**  
[SOCKET PIN SHEET METAL USE - INCH]

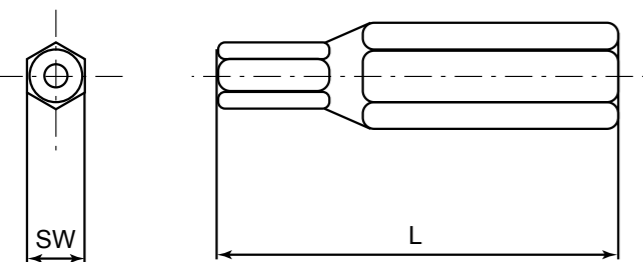

SIZE	PART NUMBER	QTY	SHANK FIT
SW 2	SFHP02B	1	1/4"
SW 2.5	SFHP025B		1/4"
SW 3	SFHP03B		1/4"
SW 4	SFHP04B		1/4"



**TP BIT FOR TRS**  
[TORX PIN SHEET METAL USE - INCH]

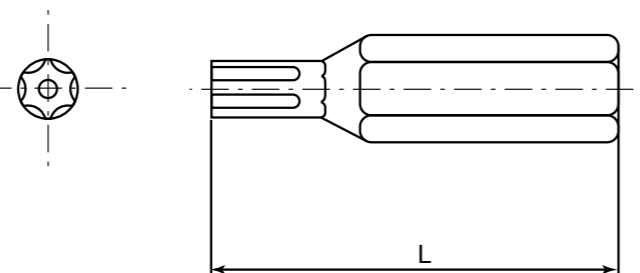

SIZE	PART NUMBER	QTY	SHANK FIT
TX10	SFTP10B	1	1/4"
TX15	SFTP15B		
TX20	SFTP20B		
TX25	SFTP25B		
TX27	SFTP27B		
TX30	SFTP30B		

## TOOLS - BITS & KEYS - INCH



**DS BIT FOR TRS**  
[DRILL SPANNER USE - INCH]

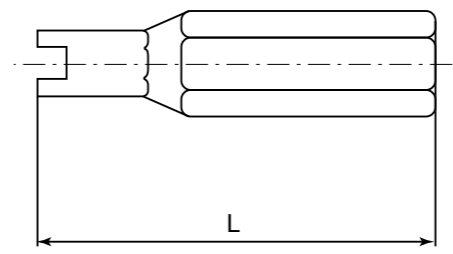

SIZE	PART NUMBER	QTY	SHANK FIT
SP4	SFDS04B	1	1/4"
SP6	SFDS06B		
SP8	SFDS08B		
SP10	SFDS10B		
SP12	SFDS12B		
SP14	SFDS14B		



**DS BIT FOR TRS**  
[DRILL SPANNER SHEET METAL USE - INCH]

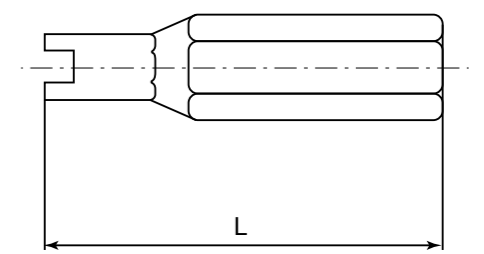

SIZE	PART NUMBER	QTY	SHANK FIT
SP4	SFDS04B	1	1/4"
SP6	SFDS06B		
SP8	SFDS08B		
SP10	SFDS10B		
SP12	SFDS12B		
SP14	SFDS14B		



**FAST DRIVER HOLDER**  
[FITS ALL BITS]

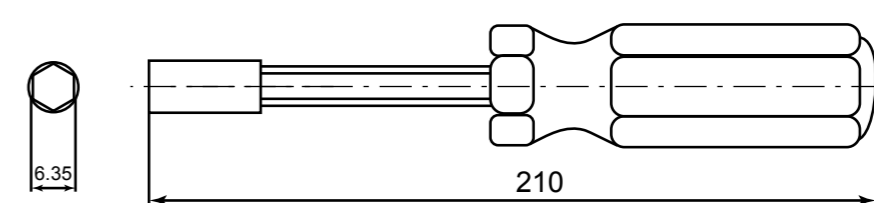

SIZE	PART NUMBER	QTY	SHANK FIT
1/4" (M6)	SFHDR01	1	6.35 (1/4")

HP



TP



DS



BACK

63

62

TOOLS - BITS & KEYS - INCH



**HP KEYS FOR TRS**  
[SOCKET PIN USE - INCH]

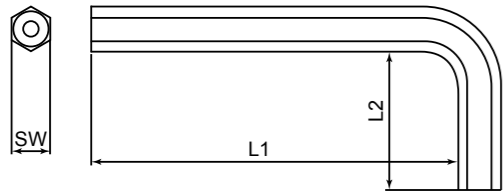

SIZE	PART NUMBER	QTY
3/32"	SFHP332L	1
1/8"	SFHP018L	
9/64"	SFHP964L	
5/32"	SFHP532L	
3/16"	SFHP316L	
7/32"	SFHP732L	
1/4"	SFHP014L	
5/16"	SFHP516L	
3/8"	SFHP038L	



**TP KEYS FOR TRS**  
[TORX PIN USE - INCH]

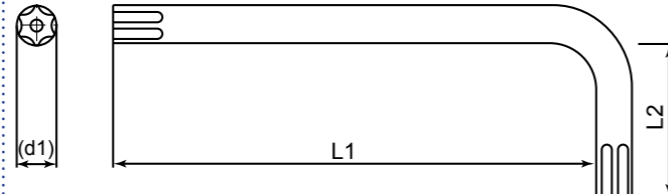

SIZE	PART NUMBER	QTY
T6	SFTP06L	1
T8	SFTP08L	
T10	SFTP10L	
T15	SFTP15L	
T20	SFTP20L	
T25	SFTP25L	
T27	SFTP27L	
T30	SFTP30L	
T40	SFTP40L	
T45	SFTP45L	



**HP KEYS FOR TRS**  
[SOCKET PIN SHEET  
METAL USE-INCH]

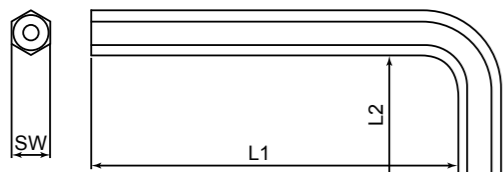

SIZE	PART NUMBER	QTY
SW 2	SFHP02L	1
SW 2.5	SFHP025L	
SW 3	SFHP03L	
SW 4	SFHP04L	



**TP KEYS FOR TRS**  
[TORX PIN SHEET  
METAL USE-INCH]

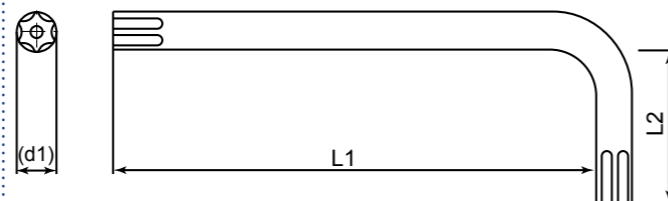

SIZE	PART NUMBER	QTY
TX10	SFTP10L	1
TX15	SFTP15L	
TX20	SFTP20L	
TX25	SFTP25L	
TX27	SFTP27L	
TX30	SFTP30L	



**SYNERGIX**<sup>®</sup>  
SECURITY SCREWS

**TAMPER  
RESISTANCE  
FASTENERS**

**ASSORTMENT SERIES**

BACK



**THEFT RESISTANT SCREW (TRS)**

**ASSORTMENT SERIES (METRIC)**

**MATERIAL: STAINLESS STEEL A2**  
**STORAGE : PLASTIC CONTAINER OF 12 COMPARTMENTS**



**HEX PIN BUTTON HEAD SCREW (M3 - M6)**

PART NUMBER	D	L	PCS	BOX
ASST-HP01-M3-M6	M3	6mm, 8mm, 10mm	20 EA X 3 = 60	1
	M4	8mm, 10mm, 12mm	20 EA X 3 = 60	
	M5	10mm, 12mm, 16mm	20 EA X 3 = 60	
	M6	12mm, 16mm, 20mm	20 EA X 3 = 60	
	04 SIZES	12 LENGTHS	240 PCS	

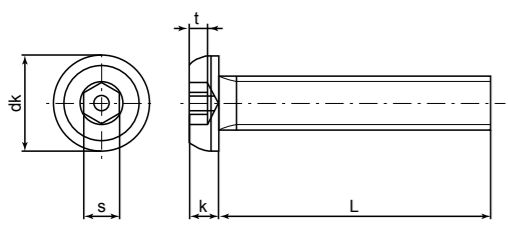

**HEX PIN BUTTON HEAD SCREW (M4 - M8)**

PART NUMBER	D	L	PCS	BOX
ASST-HP01-M4-M8	M4	8mm, 10mm, 12mm	20 EA X 3 = 60	1
	M5	10mm, 12mm, 16mm	20 EA X 3 = 60	
	M6	12mm, 16mm, 20mm	20 EA X 3 = 60	
	M8	16mm, 20mm, 25mm	10 EA X 3 = 30	
	04 SIZES	12 LENGTHS	210 PCS	

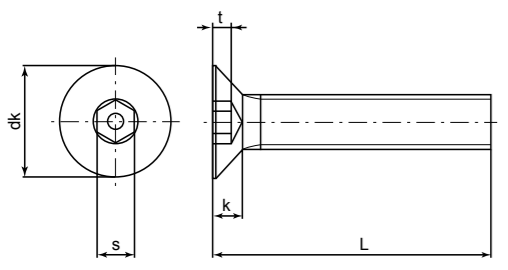

**HEX PIN FLAT HEAD SCREW (M3 - M6)**

PART NUMBER	D	L	PCS	BOX
ASST-HP02-M3-M6	M3	8mm, 10mm, 12mm	20 EA X 3 = 60	1
	M4	10mm, 12mm, 16mm	20 EA X 3 = 60	
	M5	12mm, 16mm, 20mm	20 EA X 3 = 60	
	M6	16mm, 20mm, 25mm	20 EA X 3 = 60	
	04 SIZES	12 LENGTHS	240 PCS	

**HEX PIN FLAT HEAD SCREW (M4 - M8)**

PART NUMBER	D	L	PCS	BOX
ASST-HP02-M4-M8	M4	10mm, 12mm, 16mm	20 EA X 3 = 60	1
	M5	12mm, 16mm, 20mm	20 EA X 3 = 60	
	M6	16mm, 20mm, 25mm	20 EA X 3 = 60	
	M8	20mm, 25mm, 30mm	10 EA X 3 = 30	
	04 SIZES	12 LENGTHS	210 PCS	



**TOOLS ASSORTMENT**

PART NUMBER	TOOL BIT SIZE (HEX)	PCS	BOX
ASST-HP-M3-M6-TB	2, 2.5, 3, 4	1 EA	4 PCS
ASST-HP-M4-M8-TB	2.5, 3, 4, 5	1 EA	4 PCS

**TORX PIN BUTTON HEAD SCREW (M3 - M6)**

PART NUMBER	D	L	PCS	BOX
ASST-TP01-M3-M6	M3	6mm, 8mm, 10mm	20 EA X 3 = 60	1
	M4	8mm, 10mm, 12mm	20 EA X 3 = 60	
	M5	10mm, 12mm, 16mm	20 EA X 3 = 60	
	M6	12mm, 16mm, 20mm	20 EA X 3 = 60	
	04 SIZES	12 LENGTHS	240 PCS	

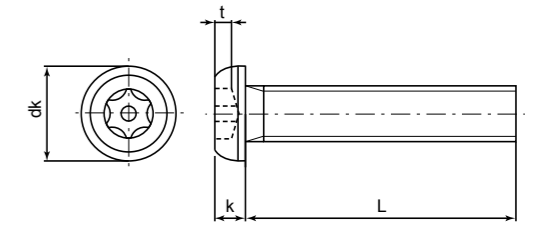

**TORX PIN BUTTON HEAD SCREW (M4 - M8)**

PART NUMBER	D	L	PCS	BOX
ASST-TP01-M4-M8	M4	8mm, 10mm, 12mm	20 EA X 3 = 60	1
	M5	10mm, 12mm, 16mm	20 EA X 3 = 60	
	M6	12mm, 16mm, 20mm	20 EA X 3 = 60	
	M8	16mm, 20mm, 25mm	10 EA X 3 = 30	
	04 SIZES	12 LENGTHS	210 PCS	

**TORX PIN FLAT HEAD SCREW (M3 - M6)**

PART NUMBER	D	L	PCS	BOX
ASST-TP02-M3-M6	M3	8mm, 10mm, 12mm	20 EA X 3 = 60	1
	M4	10mm, 12mm, 16mm	20 EA X 3 = 60	
	M5	12mm, 16mm, 20mm	20 EA X 3 = 60	
	M6	16mm, 20mm, 25mm	20 EA X 3 = 60	
	04 SIZES	12 LENGTHS	240 PCS	

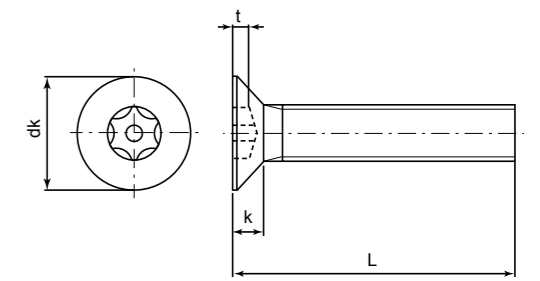

**TORX PIN FLAT HEAD SCREW (M4 - M8)**

PART NUMBER	D	L	PCS	BOX
ASST-TP02-M4-M8	M4	10mm, 12mm, 16mm	20 EA X 3 = 60	1
	M5	12mm, 16mm, 20mm	20 EA X 3 = 60	
	M6	16mm, 20mm, 25mm	20 EA X 3 = 60	
	M8	20mm, 25mm, 30mm	10 EA X 3 = 30	
	04 SIZES	12 LENGTHS	210 PCS	

**TOOLS ASSORTMENT**

PART NUMBER	TOOL BIT SIZE (TORX)	PCS	BOX
ASST-TP-M3-M6-TB	T10, T20, T25, T30	1 EA	4 PCS
ASST-TP-M4-M8-TB	T20, T25, T30, T40	1 EA	4 PCS







## THEFT RESISTANT SCREW (TRS)

### ASSORTMENT SERIES (INCH)

MATERIAL: STAINLESS STEEL 18-8  
STORAGE : PLASTIC CONTAINER OF 12 COMPARTMENTS



HEX PIN BUTTON HEAD SCREW (#4 - #10)				
PART NUMBER	D	L	PCS	BOX
ASST-HP01-#4-#10	4-40	1/4", 3/8", 1/2"	20 EA X 3 = 60	1
	6-32	3/8", 1/2", 3/4"	20 EA X 3 = 60	
	8-32	1/2", 3/4", 1"	20 EA X 3 = 60	
	10-32	1/2", 3/4", 1"	20 EA X 3 = 60	
	04 SIZES	12 LENGTHS	240 PCS	

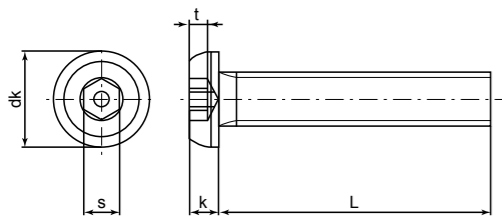

HEX PIN BUTTON HEAD SCREW (#6 - 1/4)				
PART NUMBER	D	L	PCS	BOX
ASST-HP01-#6-#14	6-32	3/8", 1/2", 3/4"	20 EA X 3 = 60	1
	8-32	1/2", 3/4", 1"	20 EA X 3 = 60	
	10-32	1/2", 3/4", 1"	20 EA X 3 = 60	
	1/4-20	3/4", 1", 1-1/2"	10 EA X 3 = 30	
	04 SIZES	12 LENGTHS	210 PCS	

HEX PIN FLAT HEAD SCREW (#4 - #10)				
PART NUMBER	D	L	PCS	BOX
ASST-HP02-#4-#10	4-40	3/8", 1/2", 3/4"	20 EA X 3 = 60	1
	6-32	1/2", 3/4", 1"	20 EA X 3 = 60	
	8-32	1/2", 3/4", 1"	20 EA X 3 = 60	
	10-32	3/4", 1", 1-1/4"	20 EA X 3 = 60	
	04 SIZES	12 LENGTHS	240 PCS	

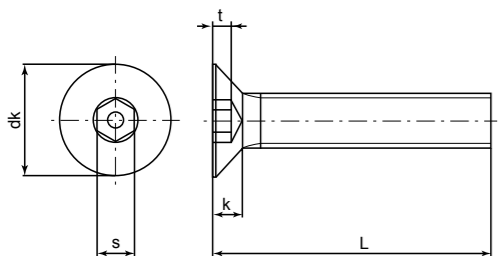

HEX PIN FLAT HEAD SCREW (#6 - 1/4)				
PART NUMBER	D	L	PCS	BOX
ASST-HP02-#6-#14	6-32	1/2", 3/4", 1"	20 EA X 3 = 60	1
	8-32	1/2", 3/4", 1"	20 EA X 3 = 60	
	10-32	3/4", 1", 1-1/4"	20 EA X 3 = 60	
	1/4-20	3/4", 1", 1-1/2"	10 EA X 3 = 30	
	04 SIZES	12 LENGTHS	210 PCS	

TOOLS ASSORTMENT			
PART NUMBER	TOOL BIT SIZE (HEX)	PCS	BOX
ASST-HP-#4-#10-TB	3/32", 1/8", 5/32"	1 EA	3 PCS
ASST-HP-#6-#14-TB	1/8", 5/32"	1 EA	2 PCS



TORX PIN BUTTON HEAD SCREW (#6 - 1/4)				
PART NUMBER	D	L	PCS	BOX
ASST-TP01-#6-#14	6-32	3/8", 1/2", 3/4"	20 EA X 3 = 60	1
	8-32	1/2", 3/4", 1"	20 EA X 3 = 60	
	10-32	1/2", 3/4", 1"	20 EA X 3 = 60	
	1/4-20	3/4", 1", 1-1/2"	10 EA X 3 = 30	
	04 SIZES	12 LENGTHS	240 PCS	

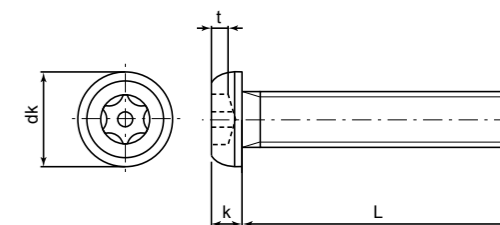

TORX PIN FLAT HEAD SCREW (#6 - 1/4)				
PART NUMBER	D	L	PCS	BOX
ASST-TP02-#6-#14	6-32	1/2", 3/4", 1"	20 EA X 3 = 60	1
	8-32	1/2", 3/4", 1"	20 EA X 3 = 60	
	10-32	3/4", 1", 1-1/2"	20 EA X 3 = 60	
	1/4-20	3/4", 1", 1-1/2"	10 EA X 3 = 30	
	04 SIZES	12 LENGTHS	210 PCS	

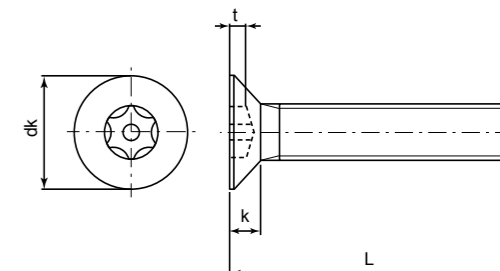

TOOLS ASSORTMENT			
PART NUMBER	TOOL BIT SIZE (TORX)	PCS	BOX
ASST-TP01-#6-#14-TB	T10, T15, T25, T27	1 EA	4 PCS
ASST-TP02-#6-#14-TB	T15, T20, T25, T30	1 EA	4 PCS



## TERMS OF SALES

### CURRENCY & PAYMENT GATEWAY

This E-Catalogue uses USD dollar for all transactions. Pay Pal, is our authorize payment gateway & DHL, is our authorize courier gateway. Both partners are operative on Global Basis.

### LIMIT OF LIABILITY STATEMENT

This web page catalog is a guide to the purchase of fasteners only. SYNERGIX does not represent that its fasteners meet government or consensual specifications unless specifically stated. SYNERGIX makes no warranty of fitness for any particular use or purpose or any other warranty, expressed or implied. All information on this web site is subject to change without notice. \*\*\*Product images are not exact representation to actual specifications, dimensions or finishing etc\*\*\*

### TERMS OF SALES

BY PURCHASING FROM SELLER (SYNERGIX SAIMA (S) PTE LTD), YOU AGREE TO THESE TERMS AND CONDITIONS. No other terms shall apply except as agreed in writing signed by us. We reserve the right to correct typographic errors and reject orders.

### LIABILITY

WE SHALL NOT BE LIABLE IN CONTRACT, WARRANTY, TORT OR OTHERWISE FOR CONSEQUENTIAL, SPECIAL, EXEMPLARY OR INCIDENTAL DAMAGES. IN NO EVENT SHALL OUR LIABILITY EXCEED THE PURCHASE PRICE.

### DELIVERY

Local DELIVERY (PO APPLICABLE ONLY). ORDERS BELOW S\$250, will be subject to self - collection basis. MULTIPLE DATES WITHIN SAME MONTH, WILL BE CONSOLE & SEND ON EARLIEST DATE OF THAT AFFECTED MONTH. \*\*\*E-Catalogue sales Purchase in SINGAPORE, No Charge, including Jurong Island\*\*\*



**SYNERGIX**<sup>®</sup>  
SECURITY SCREWS

### SYNERGIX SINGAPORE

[Singapore Head Office]

52 Ubi Ave 3,

#05-37, FRONTIER, 408867, Singapore

Phone: +65 6 316 2630

Fax: +65 6 316 2730

Website: [www.synergixfast.com](http://www.synergixfast.com)

Email: [sales@synergixfast.com](mailto:sales@synergixfast.com)